

2019

Modular Remote Power (MRP)

BayTech[®]



Copyright 2019

Bay Technical Associates, Inc

1/1/2019

Table of Contents

COMPLIANCE STANDARD	6
CONNECTION DESCRIPTION	6
EIA-232 SERIAL CONNECTION	6
10/100 BASE-T NETWORK PORT CONNECTION	6
INSTALLATION	7
UNPACKING	7
PREPARING THE INSTALLATION SITE	7
POWER	7
CIRCUIT BREAKER	9
UNIT PROCESSORS	9
CABLING	10
RJ-45 CABLE.....	10
ADAPTERS	11
SERIAL SETUP	12
OPERATION IMPORTANT:.....	12
OUTLET STATUS.....	12
PART 1: MRP SERIES	13
QUICK START:	13
OUTLET CONTROL CONFIGURATION:.....	13
ETHERNET CONFIGURATION:	14
NETWORK MENU	20
OUTLET CONTROLLER STATUS SCREEN	21
OUTLET HELP OPTIONS	22
RECEPTACLE CONTROLS	22
ON, OFF, REBOOT, LOCK, AND UNLOCK	22
STATUS	23
OSTATUS	23
OUTLET CONTROL CONFIGURATION MENU	24
<i>Manage Users</i>	24
<i>Change Outlet Name</i>	27
<i>Enable/Disable Confirmation</i>	27
<i>Enable/Disable Status Menu</i>	28
<i>Change Unit ID</i>	28
<i>Change Alarm Threshold</i>	28
<i>Change Display Orientation</i>	29
DISPLAY CURRENT ELECTRICAL CHARACTERISTICS:	29
LOGGING OUT	30
CURRENT USER PASSWORD:.....	30
IDENTIFY CURRENT USER	30
UNIT IDENTIFICATION.....	30
STATUS MENU	31
OVERALL SYSTEM STATUS	31
NETWORK STATUS.....	31
LOGGED USERS.....	31
MEMORY USAGE	31
CURRENT ROUTING CACHE	32
ROUTE SETUP.....	32

PROCESSES	32
UNITINFO DATABASE	32
NETWORK CONFIGURATION MENU:	33
STATUS	33
SERIAL PORT CONFIGURATION	34
<i>Handshaking</i>	34
<i>Baud Rate</i>	35
<i>Word Size</i>	35
<i>Stop Bits</i>	36
<i>Parity</i>	36
<i>RTS/DTR Line Driver Inactivity State</i>	36
SERIAL PORT DEVICE NAME	37
ATTENTION CHARACTER	37
DISCONNECT TIMEGUARD	37
CONNECT PORT ID ECHO.....	37
LOGIN SETUP MENU	38
<i>Access Control</i>	38
<i>Manage Users</i>	38
<i>Radius Configuration</i>	40
<i>TACACS Configuration</i>	41
NETWORK PORT CONFIGURATION	43
<i>IPv4 Configuration</i>	43
<i>IPv6 Configuration</i>	44
<i>Inactivity Timeout</i>	45
<i>Carriage Return Translation</i>	45
<i>Break Length</i>	45
<i>DHCP Enable/Disable</i>	45
<i>Telnet Enable/Disable</i>	45
<i>SSH Enable/Disable</i>	46
<i>SSH Host Key Generation</i>	46
<i>IP Filter Configuration</i>	46
<i>SNMP Configuration</i>	47
<i>Web Server Configuration</i>	48
MODULE NAME.....	49
RPC MANAGEMENT	49
<i>Temperature Alarm Threshold</i>	49
<i>Under Voltage Alarm Threshold</i>	50
<i>Over Voltage Alarm Threshold</i>	50
<i>Low Current Alarm Threshold</i>	50
<i>Environmental Sensors</i>	50
<i>Outlet Groups</i>	51
<i>Temperature Units (degrees C/F)</i>	53
<i>RPC Cascade Mode</i>	53
<i>Power Factor Threshold Menu</i>	55
FIRMWARE/CONFIG DOWNLOAD	58
<i>Enable Firmware Upgrade</i>	58
<i>Enable SSL Cert Upload</i>	58
<i>Enable Configuration File Upload</i>	59
<i>Restore Configuration Defaults</i>	59
<i>Get Current Configuration File</i>	60
<i>Display Configuration Error Log</i>	60
<i>Enable Rel Ctl. Firmware Upgrade</i>	60
UNIT RESET	61
LOGOUT	61
BAYTECH PRODUCT WARRANTY	62

EXCEPTIONS	62
BAYTECH EXTENDED WARRANTY	62
TECHNICAL SUPPORT	63
REPAIR POLICY.....	63
RETURN AUTHORIZATION PROCESS:.....	64
APPENDIX: TACACS CONNECTION SCENERIOS.....	65
HORIZONTAL RACK MOUNTS.....	66
1U BRACKET	66
2U BRACKET	66
RACK MOUNT HARDWARE	67
APPENDIX: TROUBLESHOOTING.....	68
<i>Serial 1: Port Pin out Table</i>	10
<i>Serial 2: RJ08X007 Pin out</i>	11
<i>Serial 3: RJ45 Receptacle & Plug</i>	11
<i>Serial 4: 9FRJ45PC Cisco Adapter Pin Out</i>	11
<i>Serial 5: 9FRJ45PC-1 Adapter Pin out</i>	11
<i>Figure 1: Outlet Status</i>	15
<i>Figure 2: Outlet Help</i>	15
<i>Figure 3: Outlet Password</i>	16
<i>Figure 4: Outlet Configuration</i>	16
<i>Figure 5: Outlet Manage User</i>	16
<i>Figure 6: Outlet Assignment</i>	17
<i>Figure 7: Network Menu</i>	18
<i>Figure 8: Network Configuration</i>	18
<i>Figure 9: Network Login Setup</i>	18
<i>Figure 10: Network Access Control</i>	18
<i>Figure 11: Network Login Prompt</i>	18
<i>Figure 12: Network Manage Users</i>	19
<i>Figure 13: Network Port Configuration</i>	19
<i>Outlet 1: Outlet Control Help</i>	22
<i>Outlet 2: Outlet Configuration</i>	24
<i>Outlet 3: Outlet Manage Users</i>	24
<i>Status Menu 1: Network Status</i>	31
<i>Menu 1: Network Configuration</i>	33
<i>Menu 2: Serial Port Configuration</i>	34
<i>Menu 3: Network Login</i>	38
<i>Menu 4: Network Manage User</i>	38
<i>Menu 5: Network Radius Configuration</i>	40
<i>Menu 6: Network TACACS Configuration</i>	41
<i>Menu 7: Network Port Configuration</i>	43
<i>Menu 8: Network IP Filter Configuration</i>	46
<i>Menu 9: Network SNMP Configuration</i>	47
<i>Menu 10: Web Server Configuration</i>	48
<i>Menu 11: Network RPC Management</i>	49
<i>Menu 12: Network RPC Cascade Mode</i>	53
<i>Menu 13: Network Firmware/Config Download</i>	58

ABOUT THIS OWNER'S MANUAL

This document provides information required for installing and operating your Bay Tech equipment. It should allow the user to connect to, power up, and access an applications menu where peripheral equipment can be controlled. We recommend reading this manual carefully, while placing special emphasis on correct cabling and configuration. If you have any problems with your installation, please contact a BayTech Applications Engineer at **228-563-7334**, or toll free from anywhere in the United States using **1-800-523-2702** or contact us at our Web Site, www.baytech.net.

BayTech manufactures many remote site management power products and data switches. If you would like information on any of these products, please contact BayTech Customer Service at the above numbers or visit our web site.

Conventions used in this manual include:



CAUTION: This term is used to denote any condition that could possibly result in physical harm to personnel or damage to equipment.

ATTENTION: Ce terme est employé pour dénoter n'importe quelle condition qui pourrait probablement avoir comme conséquence le mal physique au personnel ou les dommages à l'équipement.



IMPORTANT: This term is used to denote conditions that could result in the loss of communications or to highlight the proper functioning of equipment.

IMPORTANT: Ce terme est employé pour dénoter les conditions qui pourraient avoir comme conséquence la perte de communications ou accentuer le fonctionnement approprié de l'équipement.



NOTE: This term is used to denote items of interest to the user.

NOTE: Ce terme est employé pour dénoter des articles d'intérêt à l'utilisateur.

<cr>: Carriage Return or ENTER

<cr>: Le Retour chariot ou ENTRE

The information in this document is subject to change without notice. The statements, configurations, technical data, and recommendations in this document are believed to be accurate and reliable, but are presented without express or implied warranty. Users must take full responsibility for their applications of any products specified in this document. The information in this document is proprietary to Bay Technical Associates, Inc.

In the interest of improving internal design, operational function, and/or reliability, Bay Technical Associates, Inc reserves the right to make changes to the products described in this document without notice.

Bay Technical Associates, Inc does not assume any liability that may occur due to the use or application of the product(s) or circuit layout(s) described herein.

MRP = Modular Remote Power. This unit measures RMS voltage, and current. Calculates power in watts and power factor efficiency per circuit and has Environmental Sensor, RS232 and/or Direct IP ports. Controllable Outlets

We welcome any comments you may have about our products, and we hope that you will continue to look to BayTech for your remote management needs.

COMPLIANCE STANDARD

BayTech units are in accordance with the general requirements of *Standard for Information Technology Equipment* (ETL listed, conforms to ANSI/UL 60950-1 2nd Edition and CAN/CSA C22.2 No. 60950-00. CE conforms to IEC 60950.) *Equipment installations are to be in accordance with the Canadian Electrical Code, Part I, CSA C22.1-02; General Requirements – Canadian Electrical, Part II, CSA C22.2 No 0-M91; the National Electrical Code, NFPA 70-2005; and the National Electrical Safety Code, NFPA, IEEE C2-2002.*

CONNECTION DESCRIPTION

BayTech's Modular Series unit provides a Serial EIA232 interface that controls user access and outlet controls to the power strip.



CAUTION: All power should be removed from the BayTech unit prior to removing or installing cables and /or adapters.

ATTENTION: Tout pouvoir doit être retiré de l'unité BayTech avant de retirer ou d'installer des câbles et / ou des adaptateurs

EIA-232 Serial Connection

The RPC has an RJ-45 port which uses an 8-pin crossed modular cable to connect to a local EIA-232 device such as a computer terminal or external modem. Most serial computers do not have RJ-45 connections; therefore an adapter is provided with this unit to convert from a DE-9 connector to an RJ-45 connector (Bay Tech Part No. 9FRJ45PC-4). An adapter to convert from a DB-25 connector to an RJ-45 connector is also available from Bay Tech, upon request (Bay Tech Part No. 25FRJ45PC-4). The 8-pin crossed modular cable is configured to operate with these adapters.



NOTE: Custom cables are available to connect a device to this unit's serial port. These custom cables are one-way cables labeled with Baytech on one end and a device name on the other end.

REMARQUE: les câbles sur mesure sont disponibles pour connecter un périphérique au port série de cet appareil. Ces câbles sont des câbles de commande à sens unique marqué par Baytech à une extrémité et un nom de périphérique à l'autre extrémité.

10/100 Base-T Network Port Connection

Using a straight 10/100 Base-T cable, connect the RJ-45 port labeled ETHERNET on the HOST module to an RJ-45 port on the network hub. The LINK (link integrity) LED, located on the front panel of the HOST, illuminates when a good connection is established between the HOST and the hub. (**Half-duplex 100Mbs, Full duplex 10 or 100Mbs**)

INSTALLATION

Unpacking

Compare the unit and serial number of the equipment you received to the packing slip located on the outside of the box. Inspect equipment carefully for damage that may have occurred in shipment. If there is damage to the equipment or if materials are missing, contact BayTech Customer Support at **228-563-7334** or call toll free inside the United States at **800-523-2702**. At a minimum, you should receive the following:

1. The MRP unit.
2. Paper insert referencing BayTech's website at www.baytech.net/support/ftp_series.php.
3. 1 ea. DE-9 (9 pin) PC com port adapter -- 9FRJ45PC (with Cisco Interface) or 9FRJ45PC-1.
4. 1 ea. RJ-45 Roll over cable -- RJ08X007.
5. 1 set of either Vertical or Horizontal Brackets -- M140C138, M140R114, M140R115



NOTE: Keep the shipping container and packing material in the event future shipment is required.

Preparing the Installation Site

The installation area should be clean and free of extreme temperatures and humidity. Allow sufficient space behind the MRP/MMP/MSP/MDP unit for cabling and receptacle connections. Access to installation site should be restricted to authorized personnel. Installation of these units should be limited to ITE and Telco server environments.

PRÉPARATION DE L'EMPLACEMENT D'INSTALLATION

Le secteur d'installation devrait être propre et exempt des températures et de l'humidité extrêmes. Permettez le suffisamment d'espace derrière l'unité de MRP/MMP/MSP/MDP pour des raccordements de câblage et de réceptacle. L'accès à l'emplacement d'installation devrait être limité au personnel autorisé. L'installation de ces unités devrait être limitée à ITE et à environnements de serveur de Telco.

Power

- **208V 3ØY VAC Model:** Internal 120/208 VAC, 3Ø, 50/60 Hz (16, 20, 30, 32, 50 or 60 Amps Maximum Load).
- **400V 3ØY VAC Model:** Internal 230/400 VAC, 3Ø, 50/60 Hz (16, 20, 30, 32, 50, or 60 Amps Maximum Load)
- **208V VAC Model:** Internal 120/208 VAC 50/60 Hz (10, 15, 16, 20, 30, 32, 50, or 60 Amps Maximum Load).
- **120V VAC Model:** Internal 120 VAC 50/60 Hz (15, 20, 30, 50, or 60 Amps Maximum Load).



CAUTION: This unit is intended for indoor use only. Do not install near water or expose this unit to moisture. To prevent heat buildup, do not coil the power cord when in use. Do not use extension cords. Do not attempt to make any internal changes to the power source. Do not attempt to modify any portion or component of an MRP/MMP/MSP/MDP Series Unit unless specifically directed to by BayTech personnel. BayTech must perform any internal operations.

ATTENTION: Cette unité est prévue pour l'usage d'intérieur seulement. N'installez pas près de l'eau ou n'exposez pas cette unité à l'humidité. Pour empêcher l'habillage de la chaleur, ne lovez pas le cordon de secteur en service. N'employez pas les cordes de prolongation. N'essayez pas de n'apporter aucune modification interne à la source d'énergie. N'essayez pas de ne modifier aucune partie ou composant d'une unité de série de MRP/MMP/MSP/MDP à moins qu'ait spécifiquement dirigé vers par le personnel de BayTech. BayTech doit effectuer toutes les opérations internes.



CAUTION: High-voltage surges and spikes can damage this equipment. To protect from such power surges and spikes, this unit must have a good earth ground or good power surge protection.

ATTENTION: Les montées subites et les transitoires à haute tension peuvent endommager cet équipement. Pour se protéger contre de telles montées subites et transitoires de puissance, cette unité doit avoir une bonne protection rectifiée ou bonne de la terre de puissance de montée subite.



CAUTION: Do not exceed the AC current rating for the selected model.

ATTENTION: Ne dépassez pas l'estimation courante à C.A. pour le modèle choisi.



CAUTION: In order to be absolutely removed from the power supply, the power cord must be unplugged from the power source.

ATTENTION: Afin d'être absolument enlevé de l'alimentation d'énergie, le cordon de secteur doit être débranché de la source d'énergie.



CAUTION: For PERMANENTLY CONNECTED EQUIPMENT, a readily accessible disconnect device (Circuit Breaker rated not to exceed the amperage rating of the unit) shall be incorporated in the fixed wiring between the power source and the Baytech unit. For PLUGGABLE EQUIPMENT, the socket-outlet shall be installed near the equipment and easily accessible. The outlets providing power to the unit shall be protected against over current, short circuit and earth fault by suitable rated protective devices.

ATTENTION: Pour l'ÉQUIPEMENT DE MANIÈRE PERMANENTE RELIÉ, un dispositif aisément accessible de débranchement (disjoncteur évalué pour ne pas dépasser l'estimation d'ampérage de l'unité) sera incorporé dans le câblage fixe entre la source d'énergie et l'unité de BayTech. Pour l'ÉQUIPEMENT QUE L'ON PEUT BRANCHER, la douille-sortie sera installée près de l'équipement et facilement accessible. Les sorties fournissant la puissance à l'unité seront protégées contre le courant, le court-circuit et le défaut de terre finis par les dispositifs protecteurs évalués appropriés.

Applying power illuminates a green LED on the front panel and either Source1 or Source 2 LED will be lit. When the power switch is off, devices connected to the unit are not receiving power.

Appliquer le pouvoir illumine une LED verte sur le panneau de devant et Source1 ou Source 2 LED sera allumée. Quand l'interrupteur général est loin du, les appareils ont connecté à l'unité ne reçoivent pas le pouvoir.

CIRCUIT BREAKER

Depending on if the unit has circuit breakers, in the case of power overload, the circuit breaker automatically trips. Determine the cause of the tripped circuit breaker, correct the problem then reset the circuit breaker by depressing the circuit breaker switch. If an overload condition occurs, the ATS status menu is still accessible. If all circuits are closed, the circuit breaker status menu will indicate “On.” If the circuit breaker is tripped, the circuit breaker status will indicate “Off.” If no power cord is attached to the “IN” receptacle, the circuit breaker status will indicate “Off”, indicating there is no power available to the “OUT” receptacle.

208V/48A Rated Model:

(60A Maximum Over current protection Device).

208V/40A Rated Model:

(50A Maximum Over current protection Device).

208V/24A Rated Model:

(30A Maximum Over current protection Device).

208V/16A Rated Model:

(20A Maximum Over current protection Device)

208V/12A Rated Model:

(15A Maximum Over current protection Device)

400V/16A Rated Model:

(20A Maximum Over current protection Device)

120V/24A Rated Model:

(30A Maximum Over current protection Device)

120V/16A Rated Model:

(20A Maximum Over current protection Device)

Unit Processors

The unit controller has two processors, Ethernet and Outlet processors. Both processors are flash upgradable via Ethernet port. Power strips with only a Serial port must be connected to a Master unit or Baytech Data Switch to upgrade the Outlet Controller. You may contact Baytech Technical Support for the latest firmware.

Each Outlet Modules has a processor that communicates with the Outlet Controller. This processor cannot be upgraded in the field. If an upgrade is needed, Baytech Technical Support will contact you

CABLING

RJ-45 Cable

Control Module RJ-45 pin Signals

Pin	EIA 232 Signal	Signal Direction	Description
1	DTR	Out	+10V when activated by DCD. Toggles on logout for modem disconnect.
2	GND		Signal Ground
3	RTS	Out	+10 V when power is applied. Not used as a handshake line.
4	TX	Out	Transmit (Data Out)
5	RX	In	Receive (Data In)
6	N/C	In	No Connection.
7	GND		Signal Ground
8	DCD	In	DCD into the MRP.

Adapter signals

Listed are the pin specifications for the BayTech cable and adapters and the terminal COM ports:

Serial 1: Port Pin out Table

Signal	RS-232 Port (DS)	RS-232 Port (MRP)	COM Port DE-9 Pin	COM Port DB-25 Pin	Signal
DTR	1	1	4	20	DSR
GND	2	2		1	GND
RTS	3	3	7	5	CTS
TXD	4	4	3	2	RXD
RXD	5	5	2	3	TXD
DSR	6	N/C	6	6	DTR
GND	7	7	5	7	GND
CTS	8		8	4	RTS
DTR			4		DCD
DCD		8	1	8	DTR
RI	9			22	

RJ08X007 Standard Rollover Cable – RJ45 to RJ45

Serial 2: RJ08X007 Pin out

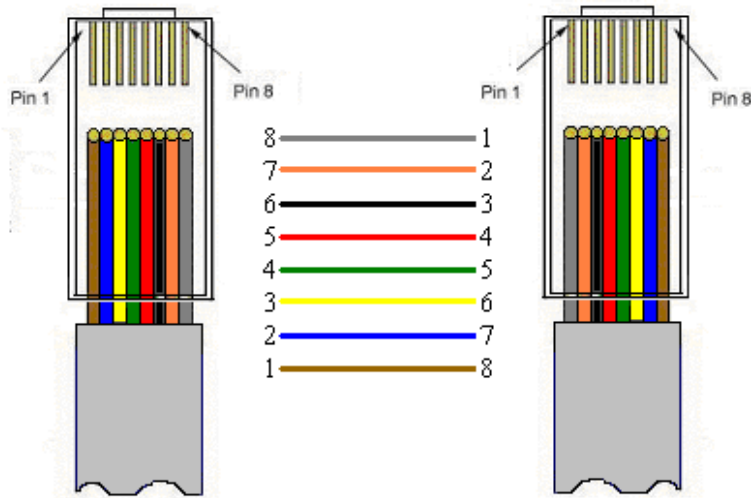

Serial 3: RJ45 Receptacle & Plug



Adapters

Serial 4: 9FRJ45PC Cisco Adapter Pin Out

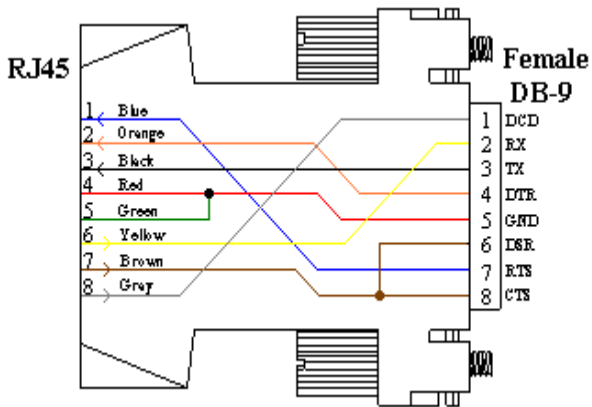

(Use with RJ08X007 Cable
 And B/C switch in "C")

Serial 5: 9FRJ45PC-1 Adapter Pin out

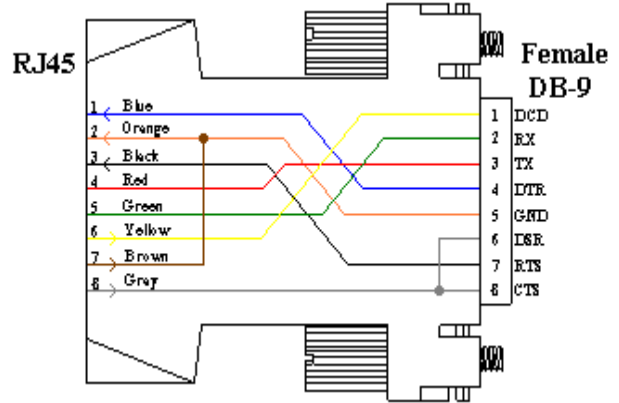

(Use with RJ08X007 Cable
 And B/C switch in "B")

SERIAL SETUP

- Connect the *9FRJ45PC-1* adapter to the user's computer
- Connect the RPC EIA-232 port to the adapter via the *RJ08X007* rolled flat ribbon cable.
- Use terminal emulation software to access the unit, **9600 bps, 8 data bits, 1stop bit, no parity, no flow control, and B/C switch set to 'B'. Set to 'C' to use Cisco Terminal Cable.**



NOTE: At any time during the session you need to go to another menu, use the **Attention Character = semi-colon (;)**. Press the attention character key 5-times to get back to the main status menu.



IMPORTANT: If a device, other than a PC, is used to connect to the serial EIA232 port, a custom cable is needed; see **Serial 1 figure above**, for serial port pin out.



IMPORTANT: **Do not connect both ends of the 8" serial cable until after the MASTER unit has been configured.**

Operation Important:

When operating remotely, do not send the command to turn "off" a receptacle that has a host terminal or modem attached. Doing so will result in the host terminal or modem being powered down creating a "locked-out" condition. You will not be able to reestablish a connection until the receptacle has been turned "on" through the serial port.



IMPORTANT: If you send the command to "reboot" a receptacle with a host terminal or modem attached, active connection to that terminal or modem is lost and will have to be reestablished.



IMPORTANT: An assigned user is allowed one active session. The admin user is allowed four sessions running concurrently.

The green LED's correspond to the unit's receptacles. An illuminated LED signifies the corresponding outlet has power turned on, thus the attached equipment has power to it. No lit LED signifies no power to the receptacle.

Outlet Status

The Modular Series are multi-user units, supporting one admin user and up to Thirty-two outlet users. The admin user has access to all outlets, user and system configuration options, unit status, and unit reset capabilities. The outlet user's status menu displays only those outlets assigned to the user's outlet list, as set by the admin user.



NOTE: The Modular Series supports one admin user. The admin user may have four sessions running concurrently. Default user name is '**root**'. User names are case sensitive.



NOTE: Each session has an inactivity timeout of ten minutes, if there is no option to set the timeout. After ten minutes of no activity elapses, the session terminates.



NOTE: The Modular Series menu is used for demonstration throughout this manual. There will be some differences in the menus dependent on the firmware revision and the number of outlets on your unit.

PART 1: MRP SERIES

QUICK START:

For those Administrators who have requested the bare minimum for this type of equipment, follow these steps exactly. If this is a new unit shipped directly from Baytech, follow the steps. If this is a previously own unit, perform a factory reset to clear out any users and passwords still in the unit.

Outlet Control Configuration:

1. Connect the 9FRJ45PC-4 or 9FRJ45PC-1 adapter to your PC.
2. Connect the supplied rollover flat cable RJ08X007 to the adapter and to the EIA232 serial port on the Baytech MRP device.
3. Use terminal emulation software to access the unit, (i.e. Microsoft Hyper-terminal). Set the PC serial port configuration to the following: **9600 bps, 8 data bits, 1stop bit and no parity**. If your device has a **B/C** switch near the EIA232 port, set it to **'B'**.
4. If you get only a blinking cursor Press 'Enter'. If still only a blinking cursor, Type 5 semi-colons (;), there is a one second delay before the menu is displayed.
5. You should get the Outlet Status menu (**Figure 1**). This is the outlet controller circuits. If you get the Network Menu (**Figure 7**), select option 1, Outlet Control or Unit (MRP 10 (2, 1) . . . 1) to get to the Outlet Status menu.
6. At prompt type **'config'** and press 'Enter'. You should see a menu similar to (**Figure 4**).
7. Select number for the Manage Users option. You should see a menu similar to (**Figure 5**).
8. **IMPORTANT NOTE:** the first user added will be the ADMIN user. Type **"A"** and press 'Enter'. Type the name of the admin user. The name is case sensitive.
9. Select the user number. You should see the user in the menu similar to (**Figure 6**).
10. Select 'Add Outlet(s)' to add a few outlets (i.e. 1, 2, 4) and press 'Enter' or select 'Add All Outlet'. A **"Y"** signifies the outlet has been assigned to the user.
11. Press 'Enter' you should see a menu similar to (**Figure 5**) with the user name. Repeat steps 7 thru 10 to add other users.
12. Once you have added the users press 'Enter' until you get back to the Outlet Status menu, (**Figure 1**). Type **"Exit"**. With (Microsoft Hyper-terminal) pressing 'Enter' will reconnect to the unit outlet controller and it will ask for a use name. If this does not happen close the terminal emulator session and open it again.
13. Type the name of a user to log in. You should see a menu similar to (**Figure 1**). The user will see only the outlets assigned to them.
14. At the prompt type **'password'** and press 'Enter'. You should see prompts similar to (**Figure 3**).
15. Enter the password for the user. Repeat steps 12 thru 14 to add or change the password of the user.

At this point you have enough Outlet Control Configurations to operate this Baytech Device. Continue to the Ethernet Controller Configuration if your unit has an Ethernet port.

This is the bare minimum for Ethernet Control. If this is a new unit shipped directly from Baytech, follow the steps. If this is a previously own unit, perform a factory reset to clear out any users and passwords still in the unit. The System Administrator should tell you to use DHCP or provide you an IP Address, Subnet Mask, and Gateway Address. **NOTE: default IP Address is 0.0.0.0**

Ethernet Configuration:

Before continuing your System Administrator needs to tell you to use DHCP or give you an IP Address, Subnet Address, and Gateway Address.

1. If this Baytech device has an Ethernet port, at the prompt of any menu type five Attention Characters (factory default is the semi-colon, {;}). The Attention Character will not echo on the screen. You should see a menu similar to **(Figure 7)**.
2. Select 'C' for the configuration menu. You should see a menu similar to **(Figure 8)**.
3. Select the number for 'Login Setup' option. You should see a menu similar to **(Figure 9)**.
4. Select the number for 'Manage Users' option. You should see a menu similar to **(Figure 12)**.
5. **NOTE: The 'root' user can not be deleted.**
6. Select 'A' to add user. Type the name and password at the prompts.
7. Press 'Enter' until get to the 'Login Setup Menu' **(Figure 9)**.
8. Select 'Access Control' to enable or disable the Tenet and Serial Login Prompt **(Figure 10)**.
9. Press 'Enter' until you get the Configuration menu **(Figure 8)**.
10. Select 'Network Port Configuration' option. You should see a menu similar to **(Figure 13)**.
11. If your System Administrator requires you to use DHCP, then select 'DHCP Enable/Disable' and type "Y" to enable DHCP. If you wish to assign a static IP address to this unit, Disable the DHCP and go to step 15.
12. Press 'Enter' until you are asked to 'Accept Changes'. Type "Y" to accept changes or "N" to decline changes.
13. After Accepting or Declining Changes you should get the Network Access Menu **(Figure 7)**.
14. Select 'Unit reset' to update the external connections. Once the reset is completed (1 minute) connect the Baytech device to your network using an Ethernet cable.
15. If you disabled the DHCP in step 11, you should see a menu similar to **(Figure 13)**.
16. Select the 'IP Address' option and type the assigned IP address and press 'Enter'.
17. Select the 'Subnet Mask' option and type the assigned subnet mask address and press 'Enter'.
18. Select the 'Gateway Address' option and type the assigned Gateway address and press 'Enter'.
19. Press 'Enter' until you are asked to 'Accept Changes'. Type "Y" to accept changes.
20. Select 'Unit reset' to update the external connections. Once the reset is completed (1 minute) connect the Baytech device to your network using an Ethernet cable.
21. You should be prompted for a user name and password, similar to **(Figure 11)**

At this point you have enough basic configurations needed to operate this Baytech unit.

Status Screen: Once the serial connection is made using the terminal software, the screen will display the inherent state of the outlets, the Average Power, RMS voltage, Current and Maximum Detected Current both in Amps, circuit breaker, Internal temperature of the unit, and external temperature sensors if connected. The number of outlets displayed depends on the MRP model.

Figure 1: Outlet Status

```

Total kW-h:    0
-----
|   Circuit   | True RMS | Peak RMS | True RMS | Average | Volt- |
|   Group    | Current  | Current  | Voltage  | Power   | Amps  |
|-----|-----|-----|-----|-----|-----|
| Circuit C1 | 0.0 Amps | 0.0 Amps | 209.5 Volts | 0 Watts | 4 VA |
| Circuit C2 | 0.0 Amps | 0.0 Amps | 209.5 Volts | 0 Watts | 4 VA |
| Circuit C3 | 0.0 Amps | 0.0 Amps | 209.5 Volts | 1 Watts | 4 VA |
| Circuit C4 | 0.0 Amps | 0.0 Amps | 207.3 Volts | 0 Watts | 4 VA |
| Circuit C5 | 0.0 Amps | 0.0 Amps | 208.3 Volts | 1 Watts | 4 VA |
| Circuit C6 | 0.0 Amps | 0.0 Amps | 209.6 Volts | 0 Watts | 4 VA |
|-----|-----|-----|-----|-----|-----|
Int. Temp:  77.9 F
Switch 1: Open 2: Open

1)...CKT 1 Outlet 1 : On      2)...CKT 1 Outlet 2 : On
3)...CKT 1 Outlet 3 : On      4)...CKT 1 Outlet 4 : On
5)...CKT 2 Outlet 1 : On      6)...CKT 2 Outlet 2 : On
7)...CKT 2 Outlet 3 : On      8)...CKT 2 Outlet 4 : On
9)...CKT 3 Outlet 1 : On     10)...CKT 3 Outlet 2 : On
11)...CKT 3 Outlet 3 : On    12)...CKT 3 Outlet 4 : On
13)...CKT 4 Outlet 1 : On    14)...CKT 4 Outlet 2 : On
15)...CKT 4 Outlet 3 : On    16)...CKT 4 Outlet 4 : On
17)...CKT 5 Outlet 1 : On    18)...CKT 5 Outlet 2 : On
19)...CKT 5 Outlet 3 : On    20)...CKT 5 Outlet 4 : On

Type Help for a list of commands

MRP-20>

```

Help Menu: Type *Help* followed by a <CR> to view the line commands for the MRP outlet control.

Figure 2: Outlet Help

```

MRP-20>help

On n <cr>      --Turn on an Outlet, n=0,1...36,all
Off n <cr>     --Turn off an Outlet, n=0,1...36,all
Reboot n <cr>  --Reboot an Outlet, n=0,1...36,all
Status <cr>   --MRP-10 Status
Ostatus <cr>  --MRP-10 Meter Outlet Status
Config <cr>   --Enter configuration mode
Lock n <cr>   --Locks Outlet(s) state, n=0,1...36,all
Unlock n <cr> --Unlock Outlet(s) state, n=0,1...36,all
Current <cr>  --Display True RMS Current
Voltage <cr>  --Display True RMS Voltage
Power <cr>    --Display Average Power
Clear <cr>    --Reset the maximum detected current
Temp <cr>     --Read current temperature
Logout <cr>   --Logoff
Logoff <cr>   --Logoff
Exit <cr>     --Logoff
Password <cr> --Changes the current user password
Whoami <cr>   --Displays the current user name
Unitid <cr>   --Displays the unit ID

Type Help for a list of commands
MRP-20>

```

Password setting: Once you have logged out and log back in as a user or as the administrator, you can then set the password to gain access. Type “Password”<cr>

Figure 3: Outlet Password

```
MRP>password
Enter new Password: *****
Re-Enter new Password: *****
Type Help for a list of commands
MRP>
```

Power Controller Configuration Menu: To select the configuration menu, type ‘config’ at the prompt.



NOTE: If the unit display with the following message, “**Configuration mode in use**” A user in the other port is in the “Configuration” menu.

Figure 4: Outlet Configuration

```
MRP>config

Unit ID: MRP20
1)...Manage Users           Add/Delete/Rename, assign outlets
2)...Change Outlet Name     Select an outlet to change its name
3)...Enable/Disable Confirmation (Y/N)
4)...Enable/Disable Status Menu Opening status of outlets
5)...Change Unit ID         As written
6)...Change Alarm Threshold As written
7)...Change Display Orientation Flip Display
X)...Exit
```

Manage User

The User Menu allows the admin user to add and delete users, change passwords, and change the outlet list that displays a user’s access to prescribed outlets. Select “Manage Users,” from the configuration menu and the following menu appears if the unit has been reset or initial setup:

Figure 5: Outlet Manage User

```
-----
|      User      |      Assigned Outlets      | | | |
|                | C1,1| C1,2| C1,3| C1,4 |
|                |-----|
-----
A)...Add User
D)...Delete User
R)...Rename User
C)...Change Circuit Group
Enter user number to assign Outlets, A, D, C or R.
Enter Request:
```



NOTE: User in position (1) will be the ‘admin user’ for the outlets. Older units will not display the ‘delete’ option until a user is added.

Add a User:

Select A), “Add user,” from the User Management Menu. Enter the name of the user to be added, followed by <cr>.



NOTE: User name is case sensitive.

Assigned Outlets

Select a user number from the User Management Menu, the MRP unit will display the Assign Outlet Menu:

Figure 6: Outlet Assignment

User	Assigned Outlets			
	C1,1	C1,2	C1,3	C1,4
1) engineer	N	N	N	N
1)...Add Outlet(s)	Add individual Outlets (X, X, X, X)			
2)...Remove Outlet(s)	Remove individual Outlets			
3)...Add All Outlets	Add all outlets to above user			
4)...Remove All Outlets	Remove all Outlets from the above user			
C)...Change Circuit Group	Display next Circuit group of outlets			
Enter Request:				



NOTE: If an outlet user's list is changed while the user is logged in, their outlet list changes dynamically. If enabled, an updated outlet status report will be issued. "Y" means the outlet is assigned to the user. "N" means the outlet is NOT assigned to the user.

Change Outlet Name: Allows the administrator to change the name of the outlets.

Enable/Disable Confirmation: Enables/Disables the confirmation of choices. Example, "Turn off all outlets [Y/N]?"

Enable/Disable Status Menu; Enables/Disables whether outlet status menu is displayed.

Change Unit ID: Allows the user to change the name of the unit. The defaulted is something similar to MRP1. Allows the user to personalize or customize name or location, up to 31 alphanumeric characters.

Change Alarm Threshold: The Alarm Threshold is the value set that sounds the amperage alarm when it reaches or exceeds the amperage value indicated.

Change Circuit Group: Allows user to flip the display for units with cords going out the top of cabinets.

Universal Ethernet Controller Configuration:

Access Menu: The Access Menu screen, allows for Outlet Operations, Network Configuration, or Disconnection. To access the Network Configuration Screen, **type five Attention Characters.**



NOTE: For initial network access, the IP address, subnet mask, and gateway must be configured from the serial port. **Default setting is 0.0.0.0.**

Figure 7: Network Menu

```

Module: 1
Attention Character: ;
MRP20          (2 ,1).....1
Status.....S          Unit Status
Configure.....C       Unit Configuration menu
Unit Reset.....RU     Terminates external connections,
                        does not affect outlet states.

Logout.....T

Enter Request :s

```

Figure 8: Network Configuration

```

Copyright(C) Bay Technical Associates 2008
URPC Ethernet Host Module
Revision F 2.25.06      Module 1
Hardware 1.00          Serial number 22222 colilo version 1.05.01

Status.....1          Status of all network options
Serial Port Configuration.....2  Setup the Serial port EIA232
Serial Port Device Name.....3    Change the EIA232 port name
Attention Character.....4        Type 5 times to access Network Main menu.
Disconnect Timeguard.....5      Data received within the delay period,
                                is data, not attention character; thereby
                                preventing unwanted port disconnection
Connect Port ID Echo.....6      Echo port name or module# & port#
Login Setup.....7              Login Menu Serial/Telnet/Radius/TACACS
                                access control, manage users
Network Port Configuration.....8  Network Port IP Address
Module Name.....9              Change name of module
MRP Management.....10          Set up Voltage/Current/Sensor threshold
Firmware / Config Download....11 Update Firmware, SSL, Configuration files
Exit.....X,CR
Enter Request :

```

Login Setup Menu

Figure 9: Network Login Setup

```

Access Control.....1
Manage Users.....2
Radius Configuration.....3
TACACS Configuration.....4
Exit.....X,CR

```

Access Control

Enable or disable usernames and passwords for both network and serial port access. If either login has been enabled you will get a prompt similar to the following:

Figure 10: Network Access Control

```

Telnet Login Prompt Enable/Disable..1
Serial Login Prompt Enable/Disable..2

```

Figure 11: Network Login Prompt

```

Universal RPC login:
Password:

```

The default user and password is “root/baytech”, all lower case.

Manage Users

Add/delete users and change their passwords. Usernames and passwords are case sensitive and alphanumeric. **The root user can not be removed.**

Figure 12: Network Manage Users

```
User Management Menu
To change user password or port access, enter number of user.
To add/delete user, select appropriate menu choice.
SNMP V3 requires passwords that are between 8 and 31 characters long
Enter request, CR to exit menus.
  A)...Add user
  1)...root
```

Network Port Configuration

For network access, you must configure the IP addresses, Subnet Mask, and Gateway Address, or enable the DHCP. The Changes must be saved and the module reset for network changes to take effect.

Figure 13: Network Port Configuration

```
Network setup :
Ethernet Address..... 00:C0:48:00:01:FD
IP Address..... 70.150.140.89
Subnet Mask..... 255.255.255.224
Default Gateway..... 70.150.140.65

Connection Inactivity Timeout (mins): Disabled
Carriage Return Translation: Enabled
Break Length (msecs): 350
DHCP is Disabled Telnet is Enabled SSH is Enabled
SSH host keys are set to factory default

IPv4 Configuration .....1
IPv6 Configuration.....2
Inactivity Timeout.....3
Carriage Return Translation.....4
Break Length.....5
DHCP Enable/Disable.....6
Telnet Enable/Disable.....7
SSH Enable/Disable.....8
SSH Host Key Generation.....9
IP Filter Configuration.....10
SNMP Configuration.....11
Web Server Configuration.....12
Exit.....X,CR

Enter Request :
```

MRP Operations and Configurations

After logging into the unit, the unit will display additional hardware information:
Outlet controller firmware, F1.11
Options installed Voltage and Current sensors and Internal Temperature Sensor.
(Opening access to internal RPC) signifies the processor is checking to see what is installed.
“Enter user name:” will appear if a user has been assigned to the Outlet Controller

```
Universal RPC login: root
Password:

                BAYTECH

For further information check:
http://www.baytech.net/

opening access to internal RPC

MRP-27 Series
(C) 2008 BayTech
F1.11

Option(s) Installed:
True RMS Voltage
True RMS Current
Internal Temperature

Enter user name:
```

NETWORK MENU

- The Network menu can be accessed through the Ethernet or Console (EIA232) port.
- I**), opens the Outlet Controller Menu, Ethernet unit.
 - 2**), opens the Outlet Controller Menu, Non-Ethernet unit.
 - O**), opens the Cascade Outlet Controller Menu.
 - S**), opens the Ethernet data Status.
 - C**), opens the Network Configuration Menu.
 - RU**), opens the reset decision.
 - T**), close session

Single Unit Menu

```
Module: 1
Attention Character: ;
MRP27          (2 ,1).....1
Status.....S
Configure.....C
Unit Reset.....RU
Logout.....T
Enter Request :
```

CASCADE ENABLED Menu

```
Module: 1
Attention Character:
MRP27          (2 ,1).....1
MRP27          (2 ,2).....2
Outlet Group Control.....O
Status.....S
Configure.....C
Unit Reset.....RU
Logout.....T

Enter Request :s
```



NOTE: Option **(2)** and option **(O)** are for units set for Cascade operations.

OUTLET CONTROLLER STATUS SCREEN

The Outlet Controller displays the measured circuit True RMS and Peak RMS current values; True RMS Voltage; Average Power, Voltage/Amps; Internal and External temperature and Humidity with attached probes; along with Open/Close external Switch probes. Also displays the outlet status. At the prompt type **“Help”** for outlet command and other menus.

```
MRP-10 Series
(C) 2008 BayTech
F1.12

True RMS Voltage
True RMS Current
Internal Temperature

Unit ID: MRP-10

Total kW-h: 8731
```

Circuit Group	True RMS Current	Peak RMS Current	True RMS Voltage	Average Power	Volt-Amps
Circuit M1	0.0 Amps	0.0 Amps	196.7 Volts	0 Watts	4 VA
Circuit M2	0.0 Amps	0.0 Amps	200.8 Volts	0 Watts	4 VA
Circuit M3	0.0 Amps	0.0 Amps	200.3 Volts	0 Watts	4 VA
Circuit M4	0.0 Amps	0.0 Amps	199.4 Volts	0 Watts	4 VA
Circuit M5	0.0 Amps	0.0 Amps	198.6 Volts	0 Watts	4 VA
Circuit M6	0.0 Amps	0.0 Amps	199.6 Volts	0 Watts	4 VA

```
Int. Temp: 115.7 F Ext. 1: 74.7 F : 52.7% RH Ext. 2: 72.0 F
1)...MOD 1 Outlet 1 : On      2)...MOD 1 Outlet 2 : On
3)...MOD 1 Outlet 3 : On      4)...MOD 1 Outlet 4 : On
5)...MOD 2 Outlet 1 : On      6)...MOD 2 Outlet 2 : On
7)...MOD 2 Outlet 3 : On      8)...MOD 2 Outlet 4 : On
9)...MOD 3 Outlet 1 : On      10)...MOD 3 Outlet 2 : On
11)...MOD 3 Outlet 3 : On     12)...MOD 3 Outlet 4 : On
13)...MOD 4 Outlet 1 : On     14)...MOD 4 Outlet 2 : On
15)...MOD 4 Outlet 3 : On     16)...MOD 4 Outlet 4 : On
17)...MOD 5 Outlet 1 : On     18)...MOD 5 Outlet 2 : On
19)...MOD 5 Outlet 3 : On     20)...MOD 5 Outlet 4 : On
21)...MOD 6 Outlet 1 : On     22)...MOD 6 Outlet 2 : On
23)...MOD 6 Outlet 3 : On     24)...MOD 6 Outlet 4 : On

Type Help for a list of commands

MRP-10>
```



NOTE: a 30 minute timer starts when first connected to the Outlet **‘RC’** screen. If you need to work in the Outlet **‘RC’** and the sub-screens for longer than 30 minutes, before the 30 minutes timeout, go to the Network menu for 30 seconds then select option-1 from the network menu to return to the Outlet **‘RC’** screen. THIS IS CANNOT BE CHANGED.



NOTE: Int. Temp = unit internal temperature. Ext = external temperature probe. Two environmental ports are available. Temperature reads in Fahrenheit or Celsius. RH = Relative humidity.



NOTE: The user will see only those outlets assigned to them by the admin user.



NOTE: The first three letters in the prompt designate a class of units with a sub-class of numbers. Classes = (MDP, MMP, MRP, MSP); i.e. MRP10 is the model number.

Type **“Help”** at the prompt to display a list of commands to change the outlet state, outlet configuration, and internal sensor measurements.

OUTLET HELP OPTIONS

Outlet 1: Outlet Control Help

```
On n <cr>      --Turn on an Outlet, n=0,1...24,all
Off n <cr>     --Turn off an Outlet, n=0,1...24,all
Reboot n <cr>  --Reboot an Outlet, n=0,1...24,all
Status <cr>    --MRP-10 Status
Ostatus <cr>  --MRP-10 Meter Outlet Status
Config <cr>    --Enter configuration mode
Lock n <cr>    --Locks Outlet(s) state, n=0,1...24,all
Unlock n <cr>  --Unlock Outlet(s) state, n=0,1...24,all
Current <cr>   --Display True RMS Current
Voltage <cr>   --Display True RMS Voltage
Power <cr>     --Display Average Power
Clear <cr>     --Reset the maximum detected current
Temp <cr>     --Read current temperature
Logout <cr>    --Logoff
Logoff <cr>    --Logoff
Exit <cr>     --Logoff
Password <cr> --Changes the current user password
Whoami <cr>   --Displays the current user name
Unitid <cr>   --Displays the unit ID
```

Receptacle Controls

On, Off, Reboot, Lock, and Unlock

These commands are to control the individual outlets. From the (MRP >) prompt, enter one of the following commands: ON n, OFF n, REBOOT n, LOCK n, UNLOCK n, where “n” is the outlet number you want to command.

Example: To turn “On” Outlet 3, type **ON 3** from the MRP prompt. If the confirmation option is turned on, the UNIT will display the following:

```
Turn On Outlet 3 (Y/N)?
```

Type “**Y**” for yes or “**N**” for no. Likewise, typing “**ON ALL**”, “**ON 0**”, or “**ON**” at the MRP > prompt and responding “**Y**” for yes, turns ‘**On**’ all outlets. The **OFF n** command work similarly as the **ON n** command.

The **REBOOT n** command will reboot or reset equipment attached to corresponding receptacle(s). When the command to REBOOT (n) is sent from the MRP > prompt, the MRP powers ‘**Off**’ the corresponding outlet(s) for approximately 10 seconds, then powers them ‘**On**’ in sequence. This command only works on outlets which were ‘**On**’ prior to receiving the reboot command.

The **LOCK n** command is an **admin user** only command. This command allows the admin user to lock an outlet in its current state. The user assigned to the outlet will not be able to change the outlet’s state.

Example: To lock Outlet 1, type lock 1 at the MRP prompt.

```
MRP10>lock 1,
Lock Outlet 1 (Y/N)? y
```

Type “**Y**” for yes or “**N**” for no. The status of Outlet 1 will be changed to ‘**Locked**’. Likewise, typing “**LOCK ALL**”, “**LOCK 0**”, or “**LOCK**” at the MRP > prompt and responding “**Y**” for yes, ‘**Locks**’ all outlets. The **UNLOCK n** command works similarly as the **LOCK n** command.

STATUS

This shows the current status of all circuit to the circuit breaker level. It shows Circuit Groups, True RMS Current, Peak RMS Current, True RMS Voltage, Average Power, and Volt-Amps. Status also shows whether the outlets are on, off, or locked. **NOTE:** Each module draws about 4VA with nothing plugged in to the module outlets, due to the sensors on the module.

Unit ID: MRP10

Total kW-h: 0

Circuit Group	True RMS Current	Peak RMS Current	True RMS Voltage	Average Power	Volt-Amps
Circuit C1	0.0 Amps	0.7 Amps	202.2 Volts	0 Watts	4 VA
Circuit C2	0.0 Amps	0.0 Amps	204.1 Volts	0 Watts	4 VA
Circuit C3	0.2 Amps	0.5 Amps	202.9 Volts	0 Watts	52 VA
Circuit C4	0.6 Amps	0.9 Amps	202.3 Volts	50 Watts	123 VA
Circuit C5	1.3 Amps	1.8 Amps	203.7 Volts	92 Watts	265 VA
Circuit C6	0.9 Amps	1.4 Amps	206.0 Volts	74 Watts	199 VA

Int. Temp: 95.9 F Ext. 1: 72.3 F : 31.5% RH Ext. 2: 71.1 F

1)...Outlet 1 : On 2)...Outlet 2 : On
 3)...Outlet 3 : On 4)...Outlet 4 : On
 5)...(RIGHT) Outlet : On 6)...Outlet 6 : On
 7)...Outlet 7 : On 8)...Outlet 8 : On
 9)...Outlet 9 : On 10)...Outlet 10 : On
 11)...Outlet 11 : On 12)...(LEFT) Outlet 1 : On
 13)...Outlet 13 : On 14)...Outlet 14 : On
 15)...Outlet 15 : On 16)...Outlet 16 : On
 17)...Outlet 17 : On 18)...Outlet 18 : On
 19)...Outlet 19 : On 20)...Outlet 20 : On
 21)...Outlet 21 : On 22)...Outlet 22 : On
 23)...Outlet 23 : On 24)...Outlet 24 : On
 25)...Outlet 25 : On 26)...Outlet 26 : On
 27)...Outlet 27 : On 28)...Outlet 28 : On
 29)...Outlet 29 : On 30)...Outlet 30 : On

Ostatus



IMPORTANT: This option is available **ONLY** if the Cascade feature has been enabled.

Ostatus shows Outlet names by Circuit number and outlet number, True RMS Current, Peak RMS Current, True RMS Voltage, Average Power, Volt-Amps and Outlet State.

Total kW-h: 10

Circuit Breaker	True RMS Current	Peak RMS Current
CKT1	0.3 Amps	0.6 Amps
CKT2	0.6 Amps	0.7 Amps

Circuit Group	True RMS Current	Peak RMS Current	True RMS Voltage	Average Power	Volt-Amps
Circuit M1	0.2 Amps	0.3 Amps	128.2 Volts	10 Watts	27 VA
Circuit M2	0.0 Amps	0.1 Amps	218.9 Volts	0 Watts	3 VA
Circuit M3	0.1 Amps	0.1 Amps	219.6 Volts	0 Watts	31 VA
Circuit M4	0.2 Amps	0.2 Amps	221.7 Volts	0 Watts	44 VA
Circuit M5	0.2 Amps	0.2 Amps	223.0 Volts	0 Watts	53 VA
Circuit M6	0.2 Amps	0.2 Amps	222.7 Volts	0 Watts	52 VA

Int. Temp: 89.6 F
 Switch 1: Open 2: Open

1)...MOD 1 Outlet 1 : On 2)...MOD 1 Outlet 2 : On
 3)...MOD 1 Outlet 3 : On 4)...MOD 1 Outlet 4 : On
 5)...MOD 1 Outlet 5 : On 6)...MOD 1 Outlet 6 : On
 7)...MOD 2 Outlet 1 : On 8)...MOD 2 Outlet 2 : On
 9)...MOD 2 Outlet 3 : On 10)...MOD 2 Outlet 4 : On
 11)...MOD 2 Outlet 5 : On 12)...MOD 3 Outlet 1 : On
 13)...MOD 3 Outlet 2 : On 14)...MOD 3 Outlet 3 : On
 15)...MOD 3 Outlet 4 : On 16)...MOD 3 Outlet 5 : On
 17)...MOD 3 Outlet 6 : On 18)...MOD 4 Outlet 1 : On
 19)...MOD 4 Outlet 2 : On 20)...MOD 4 Outlet 3 : On
 21)...MOD 4 Outlet 4 : On 22)...MOD 4 Outlet 5 : On
 23)...MOD 5 Outlet 1 : On 24)...MOD 5 Outlet 2 : On
 25)...MOD 5 Outlet 3 : On 26)...MOD 5 Outlet 4 : On
 27)...MOD 5 Outlet 5 : On 28)...MOD 5 Outlet 6 : On
 29)...MOD 6 Outlet 1 : On 30)...MOD 6 Outlet 2 : On
 31)...MOD 6 Outlet 3 : On 32)...MOD 6 Outlet 4 : On
 33)...MOD 6 Outlet 5 : On

Outlet Control Configuration Menu

To select the configuration menu, type 'config' at the prompt.



NOTE: If the unit display with the following message, "Configuration mode in use" Another user is in the other port in the "Configuration" menu.

Outlet 2: Outlet Configuration

```
Unit ID: MRP Power-20
1)...Manage Users           Add/Delete/Rename, assign outlets
2)...Change Outlet Name     Select an outlet to change its name
3)...Enable/Disable Confirmation (Y/N)
4)...Enable/Disable Status Menu Opening status of outlets
5)...Change Unit ID         As written
6)...Change Alarm Threshold As written
7)  Change Display orientation As written
X)...Exit
```

Manage Users

Select 1), from the Outlet Control Menu allows the admin user to add and delete users, change passwords, and change the outlet list that displays a user's access to prescribed outlets. Select "Manage Users," from the configuration menu and the following menu appears if the unit has been reset or initial setup:

Outlet 3: Outlet Manage Users

```
-----
|           User           |   Assigned Outlets   |
|           |           | | C1,1| C1,2| C1,3| C1,4| |
|-----|-----|-----|-----|
A)...Add User
D)...Delete User
R)...Rename User
C)...Change Circuit Group
Enter user number to assign Outlets, A, D, C or R.
Enter Request:
```

Add a User:



NOTE: If the "Add user" option is NOT present than the maximum number of users have been assigned. You will get a message saying 'No more users can be added'.

Select A), adds a user. The unit will prompt for a user name:



NOTE: the first assigned user will be the 'admin user' for the outlets. Older units will not display the 'delete' option unit a user is added.

Enter user name:



Type the user name followed by <cr>. **NOTE:** User name is case sensitive. The unit will display the User Menu with the added user name.

```
-----
|           User           |   Assigned Outlets   |
|           |           | | C1,1| C1,2| C1,3| C1,4| |
|-----|-----|-----|-----|
1...Engineer   | N | Y | N | Y |
|-----|-----|-----|-----|
A)...Add User
D)...Delete User
R)...Rename User
C)...Change Circuit Group
Enter user number to assign Outlets, A, D, C or R.
Enter Request:
```

Delete a User:

Select **D**), deletes a user. The unit will prompt for the user number:

Enter number for user to delete:

Type the number of the user to be deleted, followed by <cr>. The unit will display the User Menu minus the deleted user.



NOTE: If an outlet user is deleted and is logged in at the time, the outlet user will be disconnected. If you delete the user in the first position, the UNIT will display the following:

You are deleting the current admin user. The next user will become the admin user, do you want to continue. (Y/N)?



IMPORTANT: If the unit has not had a power cycle or unit reset command performed recently, before you delete the user in the first position, perform a unit reset command from the main menu. This action will prevent the unit from having **NO Admin** user assigned even though the first position user was deleted and there is a second user assigned. If the **NO Admin** condition occurs, *reset the unit to factory defaults*.

Rename a User:

Select **R**), changes the name of a user. The unit prompts for the user number.

Enter user number to rename:

Type the number of the user to be renamed, followed by <cr>. The unit will prompt for the new name:

Enter user name:

Once accepted the unit displays the User Menu with new name

Change Circuit Group:

The group is based on outlets to circuit breaker, i.e. one breaker unit will displays all outlets. Two breaker units have two groups of outlets, but will displayed one group at a time.

```
-----  
|           User           |   Assigned Outlets   | | | |
|                         | C1,1| C1,2| C1,3| C1,4|  
|                         |-----|  
A)...Add User  
D)...Delete User  
R)...Rename User  
C)...Change Circuit Group  
  
Enter user number to assign Outlets, A, D, C or R.  
Enter Request: c
```

Select **C**), selects the next outlet group, the unit displays the following:

```
-----  
|           User           |   Assigned Outlets   | | | |
|                         | C2,1| C2,2| C2,3| C2,4|  
|                         |-----|
```

Assigned Outlets

The Assigned Outlet Menu displays the outlets a user can access.

Select a **user number** from the Managed User Menu, the unit will display the Assign Outlet Menu:

User		Assigned Outlets			
		C1,1	C1,2	C1,3	C1,4
1)	Engineer	N	Y	N	N

A)...Add User
 D)...Delete User
 R)...Rename User
 C)...Change Circuit Group
 Enter user number to assign Outlets, A, D, C or R.



NOTE: If an outlet user's list is changed while the user is logged in, their outlet list changes dynamically. If enabled, an updated outlet status report will be issued. "Y" means the outlet is assigned to the user. "N" means the outlet is NOT assigned to the user.

User		Assigned Outlets			
		C1,1	C1,2	C1,3	C1,4
1)	Engineer	N	Y	N	N

1)...Add Outlet(s)
 2)...Remove Outlet(s)
 3)...Add All Outlets
 4)...Remove All Outlets
 C)...Change Circuit Group

Select 1), assigns an outlet to a user. The unit will prompt for outlet number:

Enter Outlet number(s):

Type the number of the outlet to be assign. For example, if you want engineer to have access to Outlet (C1,2), enter the number 2, followed by <cr>. If you want engineer to have access to Outlets (C1,2), (C1,3), and (C1,4) enter the numbers 2, 3, and 4 separated by commas followed by <cr>.

The unit redisplay the Assigned Outlet Menu of the user with a "Y" for the assigned outlets.

User		Assigned Outlets			
		C1,1	C1,2	C1,3	C1,4
1)	Engineer	N	Y	N	N

1)...Add Outlet(s)
 2)...Remove Outlet(s)
 3)...Add All Outlets
 4)...Remove All Outlets
 C)...Change Circuit Group

Select 2), removes individual outlets from a user. The unit will prompt for outlet number

Enter Outlet number(s):

Type the number of the outlet to be removed from the user's access. For example, if you want to remove Outlet (C1,2), enter the number 2, followed by <cr>. If you want engineer to have access to Outlets (C1,2), (C1,3), and (C1,4) enter the numbers 2, 3, and 4 separated by commas followed by <cr>. The unit redisplay the Assigned Outlet Menu of the user with an "N" for the outlets NOT assigned.

User		Assigned Outlets			
		C1,1	C1,2	C1,3	C1,4
1)	Engineer	N	Y	N	N

1)...Add Outlet(s)
 2)...Remove Outlet(s)
 3)...Add All Outlets
 4)...Remove All Outlets

Select 3), adds all outlets to user access. The unit will display “Y” for all outlets

User	C1,1	C1,2	C1,3	C1,4
1) Engineer	Y	Y	Y	Y

1)...Add Outlet(s)
 2)...Remove Outlet(s)
 3)...Add All Outlets
 4)...Remove All Outlets

Select 4), removes all outlets from user access. The unit will display “N” for all outlets

User	C1,1	C1,2	C1,3	C1,4
1) Engineer	N	N	N	N

1)...Add Outlet(s)
 2)...Remove Outlet(s)
 3)...Add All Outlets
 4)...Remove All Outlets

Change Outlet Name

Select 2), from the Outlet Control Menu allows the admin user to change the names of the outlets. Select this option and the unit displays all of the outlet names.

1)...Outlet	1
2)...Outlet	2
3)...Outlet	3
4)...Outlet	4
5)...Outlet	5
6)...Outlet	6
7)...Outlet	7
8)...Outlet	8
Enter Request:	1

Type the number of the outlet to be changed. For example to change the name of Outlet 4, type the number “4” at the “Enter Request” prompt, followed by <cr>. The unit will ask if you want to modify the current name. Type “N” to keep the same name, or type “Y” to change the name. “Y” will cause the unit to prompt for a new name.

Current Outlet: Outlet 4
 Modify (Y/N)? y

Enter :

Type a new receptacle name (maximum 16 characters), followed by <cr>. For example, change the name of Outlet 4 to Router 1 by typing Router 1 at the “Enter Request” prompt, followed by <cr>. The unit redisplay the outlet menu with the new name to Outlet 4.

1)...Outlet	1
2)...Outlet	2
3)...Outlet	3
4)...Router	1
5)...Outlet	5
6)...Outlet	6
7)...Outlet	7
8)...Outlet	8
Enter Request:	1

Enable/Disable Confirmation

Select 3), from the Outlet Control Menu enables a command confirmation. Prior to executing a command the unit will ask if what to execute the command, Y/N.. The will display the following: **Default setting is Enabled.**

Enable Confirmation (Y/N)? y

Type “Y” to enable the confirmation option, or type “N” to disable. If the confirmation feature is enabled and a command is sent to TURN ON, TURN OFF, OR REBOOT a receptacle, the unit will ask to confirm the command. For example, the command “ON 3” is sent, and the unit will display the following:

Turn On Outlet 3? (Y/N)

If this feature is disabled, the unit will perform the command and redisplay the previous menu.

Enable/Disable Status Menu

Select 4), from the Outlet Control Menu enables the Status menu. The unit will display the option to change the current status: **Default setting is Enabled.**

If this feature is disabled, only the prompt appears, else the following status menu appears.

Enable Status Menu (Y/N)? y

```
Unit ID: MRP
-----
|   Outlet   | True RMS | Peak RMS |
|   Group   |  Current |  Current |
-----
| Outlet 1-8 | 0.2 Amps | 0.2 Amps |
-----
Internal Temperature: 73.4 F

Switch 1: Open 2: Open

1)...Outlet 1      : On
2)...Outlet 2      : On
3)...Outlet 3      : On
4)...Outlet 4      : On
5)...Outlet 5      : On
6)...Outlet 6      : On
7)...Outlet 7      : On
8)...Outlet 8      : On

Type Help for a list of commands

MRP>
```

Change Unit ID

Select 5), from the Outlet Control Menu changes the Unit ID. The unit will display the following:

The default ID is the unit’s number, in this case **MRP20**

Current Unit ID: MRP20
 Modify (Y/N)? y
 Enter New Unit ID: Cab7_Rack1 MRP20

Change Alarm Threshold

Select 6), from the Outlet Control Menu allows the user to set the current level for the internal alarm to sound. This setting is only available on units with current monitoring circuitry.

If the number of circuit breakers equals the number of modules, the unit will display the following:

Circuit C1buzzer alarm value : 12.0 Amps
 Modify (Y/N)? y
 Enter: 2.0

Type “N” to keep the current value or type “Y” to change the value and enter the new value, followed by ‘Enter’ and the unit will display next circuit group.

Circuit C2 buzzer alarm value : 7.0 Amps
 Modify (Y/N)? n

If the number of circuit breakers **DOES NOT** equals the number of modules, the unit will display the following:

1)...Circuit Breaker Alarms
 2)...Module/Group Circuit Breaker Alarms

Select 1), *Circuit Breaker Alarms*, changes the alarm level per circuit breaker.

Circuit breaker 1 buzzer alarm value : 12.0 Amps
 Modify (Y/N)? y
 Enter: 15

Circuit breaker 2 buzzer alarm value : 12.0 Amps
 Modify (Y/N)? y

Select 2), *Module/Group Circuit Breaker Alarms* changes the alarm level per module.

Type “N” to keep the current value or type “Y” to change the value and enter the new value, press “Enter” and the unit will display next circuit group.

Circuit M1 buzzer alarm value : 12.0 Amps
 Modify (Y/N)? y
 Enter: 10

Circuit M2 buzzer alarm value : 12.0 Amps
 Modify (Y/N)? y
 Enter: 10

Default setting is 12.0 Amps.

Change Display Orientation

Select 7), from the **Outlet Control Menu** flips the data displayed in the LCD/LED screen on the unit controller.
 The unit will display either of the following:

Flip Display (Y/N)? y

Or

Normal Display (Y/N)? y

Display Current Electrical Characteristics:

Type “**current**” at the prompt to show the unit’s True RMS Current and Peak RMS Current, and the unit will display the following:

Circuit Group	True RMS Current	Peak RMS Current
Circuit C1	0.0 Amps	0.7 Amps
Circuit C2	0.0 Amps	0.0 Amps
Circuit C3	0.1 Amps	0.5 Amps
Circuit C4	0.0 Amps	0.9 Amps
Circuit C5	1.2 Amps	1.8 Amps
Circuit C6	0.9 Amps	1.4 Amps

Type “**clear**” at the prompt to reset the Peak RMS Current, the unit will redisplay the status menu with the new maximum detected current.

Type “**Voltage**” at the prompt to display the unit’s True RMS Voltage, and the unit will display the following.

Circuit Group	True RMS Voltage
Circuit C1	201.9 Volts
Circuit C2	204.3 Volts
Circuit C3	202.4 Volts
Circuit C4	202.1 Volts
Circuit C5	204.5 Volts
Circuit C6	205.8 Volts

Type **“Power”** at the prompt to show the unit’s Average Power and the unit will display the following.

Total kW-h: 0		
Circuit Group	Average Power	Volt-Amps
Circuit M1	0 Watts	4 VA
Circuit M2	0 Watts	4 VA
Circuit M3	0 Watts	4 VA
Circuit M4	0 Watts	4 VA
Circuit M5	0 Watts	4 VA
Circuit M6	0 Watts	4 VA

Type **“temp”** at the prompt to show the unit’s current temperature, the units will display the following:

Int. Temp: 95.9 F	Ext. 1: 72.1 F	: 31.5% RH
Ext. 2: 70.9 F		



NOTE: Units with external sensor ports will be displayed as Ext 1 and/or Ext 2.

Logging Out

Type **“Logout”**, **“Logoff”**, or **“Exit”** at the prompt to logoff from the unit. This will close the Outlet Control session. Press **“Enter”** to open the Outlet Controller session. A login prompt may appear if a user has been assign to an outlet. Newer firmware may go to the network menu.

Current User Password:

Type **“Password”** at the prompt to change the current user’s password and the unit will display the following:

Enter new Password: Re-Enter new Password:

If the current user already has a password the unit will display the following:

Enter old Password: Enter new Password: Re-Enter new Password:
--



NOTE: If you do not have the user’s current password, delete the user. Reinstall user. Select option to change password and the unit will respond asking for a new password

Identify Current User

Type **“Whoami”** at the prompt to determine the current user, the unit displays the following:

Current User: root

To change the user, logout of the unit and log back in using the new user name.

Unit Identification

Type **“unitid”** at the prompt to determine the Unit ID, the MRP displays the following:

Unit ID: MRP10

To change the unit ID, go the Outlet Configuration menu and select ‘Change Unit ID’ option. The maximum field length is 32 or 16 for older units.

STATUS MENU

Status Menu 1: Network Status

```
URPC Status Menu.  
Enter selection, CR to exit.  
  
Overall System Status.....1    Available memory, System up time  
Network Status.....2          IP address, MAC, packets  
Logged Users.....3            Active users, admin terminates users  
Memory Usage.....4           Memory statuses  
Current Routing Cache.....5    Current routing caches  
Route Setup.....6            Routing table  
Processes.....7              Processes in memory  
UnitInfo Database.....8       Data collection  
  
Enter Request :
```

Overall System Status

Select 1), System Status provides information about the local memory, how many TCP sockets are in use, and the time the unit has been operating since the last unit reset or power up.

```
System Status:  
Available local memory: 7598080  
TCP sockets in use:      0  
System up time (dd:hh:mm:ss): 0:00:50:10  
Press ENTER to continue
```

Network Status

Select 2), Network Status contains the MAC address, IP address, Mask, TX/RX packets and their status.

```
eth0  Link encap:Ethernet HWaddr 00:C0:48:00:01:FD  
inet addr:192.168.2.136 Bcast:192.168.2.255 Mask:255.255.255.0  
UP BROADCAST RUNNING MULTICAST MTU:1500 Metric:1  
RX packets:0 errors:0 dropped:0 overruns:0 frame:0  
TX packets:0 errors:0 dropped:0 overruns:0 carrier:0  
collisions:0 txqueuelen:100  
Base address:0x840  
  
lo    Link encap:Local Loopback  
inet addr:127.0.0.1 Mask:255.0.0.0  
UP LOOPBACK RUNNING MTU:16436 Metric:1  
RX packets:0 errors:0 dropped:0 overruns:0 frame:0  
TX packets:0 errors:0 dropped:0 overruns:0 carrier:0  
collisions:0 txqueuelen:0  
  
Press ENTER to continue
```

Logged Users

Select 3), shows the name of the user account, the type of interface (serial or network) and the status of the active sessions

```
C=configuration user *=current process  
Active Users:  
  
# USER   FROM           INTERNAL CONN STATUS PID  
1 root   localhost      Normal 23  
C 2 root   70.150.140.69  Normal 490  
* 3 root   70.150.140.66  Normal 492  
  
Strike T, CR to terminate a connection/process, CR to continue :
```

Terminate a session by typing "T" at the prompt. The unit will display the following:

```
Enter number of connection to terminate, CR :
```

Memory Usage

Select 4), shows your memory being utilized.

```
total:   used:   free:   shared: buffers:  cached:  
Mem: 11735040 4136960 7598080      0 380928 458752  
Swap:      0      0      0  
Press ENTER to continue
```

Current Routing Cache

Select 5), displays the IP Data currently held in cache or none upon power cycle.

Kernel IP routing cache							
Source	Destination	Gateway	Flags	Metric	Ref	Use	Iface
66.186.36.195	70.150.140.86	70.150.140.86	1	0	0	1	lo
70.150.140.86	66.186.36.195	70.150.140.65		0	0	0	eth0
70.150.140.69	70.150.140.86	70.150.140.86	il	0	0	154	lo
207.206.133.250	70.150.140.86	70.150.140.86	1	0	0	76	lo

Press ENTER to continue

Route Setup

Select 6), Every TCP/IP client machine, regardless of operating system, needs to make decisions about where to send a packet after it has been addressed. The route table is the network map that tells your Baytech product how to deliver the packet to its network addressee.

- **Destination** is a list of routes. "0" represents any number.
- **Gateway** is the network gateway for the route. The connection point to your company network.
- **Genmask** defines how closely an address must match the network destination, octet by octet, to use the route.
- **Iface** interface used to reach the network gateway, in this case Baytech network card.

Kernel IP routing table						
Destination	Gateway	Genmask	Flags	Metric	Ref	Use Iface
192.168.2.0	*	255.255.255.0	U	0	0	0 eth0
127.0.0.0	*	255.0.0.0	U	0	0	0 lo
default	192.168.2.1	0.0.0.0	UG	0	0	0 eth0

Press ENTER to continue

Processes

Select 7), displays a list of Process commands used by the firmware to operate.



IMPORTANT: If a process is terminated, the functionality of the unit maybe interrupted. To reestablish the unit's functionality, power the unit off than on.

PID	PORT	STAT	SIZE	SHARED	%CPU	COMMAND
1		S	133K	0K	0.2	init
2		S	0K	0K	0.0	keventd
6		S	0K	0K	0.0	kupdated
11		R	43K	0K	99.3	baytechd
12		S	13K	0K	0.1	mdmautoloadind
13	S0	S	13K	0K	0.1	/bin/autologind
14		S	14K	0K	0.0	/bin/inetd
17		S	133K	0K	0.1	rpccmdd
18		S	13K	0K	0.0	snmppolld
19		S	1833K	0K	0.0	snmpd
25	S0	R	71K	0K	1.0	ds62

Strike T, CR to terminate a connection/process, CR to continue :

Type "T", and the unit will prompt for a PID number to terminate:

Enter PID process to terminate, CR:

UnitInfo Database

```
unitInfo->portUser 0
unitInfo->cfgUser 0
unitInfo->connState 0
unitInfo->connPid 0
unitInfo->buildUserTableFlag 0
unitInfo->kill_poller 0
unitInfo->background_polling=0
bcTable->connAttempt=0
```

NETWORK CONFIGURATION MENU:



NOTE: The following message, “**Configuration mode in use**”, signifies a user in the other port is in the “Configuration” menu.

Menu 1: Network Configuration

```
Copyright(C) Bay Technical Associates 2009
URPC Ethernet Host Module
Revision F 2.25.06      Module 1
Hardware 1.01          Serial number 25920003 colilo version 1.05.01

Status.....1      Status of all network options
Serial Port Configuration.....2  Setup the Serial port EIA232
Serial Port Device Name.....3    Change the EIA232 port name
Attention Character.....4        Type 5 times to access Network Main menu.
Disconnect Timeguard.....5      Data received within the delay period,
                                 is data, not attention character; thereby
                                 preventing unwanted port disconnection
Connect Port ID Echo.....6      Echo port name or module# & port#
Login Setup.....7              Login Menu Serial/Telnet/Radius/TACACS
                                 access control, manage users
Network Port Configuration.....8  Network Port IP Address
Module Name.....9              Change name of module
RPC Management.....10          Set up Voltage/Current/Sensor threshold
Firmware / Config Download....11 Upload FTP firmware, upload and download
                                 unit configuration

Exit.....X,CR
Enter Request :
```

Status

Select 1), displays the current configuration of the unit network information.

```
Installed Modules :01
Attention Character is ..... ;
Disconnect Time Guard is..... Disabled
Port ID Echo is..... Disabled
Module Name is..... Universal RPC

Network Connectivity & Login Configuration:
Ethernet Address..... 00:C0:48:35:DD:40
IP Address..... 192.168.2.214
Subnet Mask..... 255.255.255.0
Default Gateway..... 192.168.2.1
Inactivity Timeout (mins)..... Disabled
Break Length (msecs)..... 350
Telnet..... Enabled
SSH..... Enabled
DHCP..... Disabled
Telnet login prompt is..... Enabled
Serial login prompt is..... Disabled
RPC Cascade Mode is..... Disabled

SNMP & Web Configuration:
SNMP Agent is..... Enabled
SNMP Trap Host 1 Address..... 0.0.0.0
SNMP Trap Host 2 Address..... 0.0.0.0
SNMP Trap Host 3 Address..... 0.0.0.0
SNMP Trap Host 4 Address..... 0.0.0.0
SNMP Read-Only Community..... public
SNMP Read-Write Community..... private
```

Status continued.

```
Web Server is..... Enabled
Web Login is..... Disabled
Web Secure Connection is..... Disabled
Web Activity Timeout is..... Disabled

Radius Setup:
Radius Logins are..... Disabled
Radius Primary Server Address... 0.0.0.0
Radius Backup Server Address... 0.0.0.0
Radius Secret..... HardlyASecret
Radius Login Timeout..... 5
URPC Usernames as Backup is.... Disabled

TACACS Setup:
TACACS Logins are..... Disabled
TACACS Server Address..... 0.0.0.0
TACACS Server Address..... 0.0.0.0
TACACS Secret..... HardlyASecret
TACACS encryption is..... Enabled
URPC Usernames as Backup is.... Disabled
TACACS Server Port is..... 49
TACACS DS62 privilege level is.. Disabled
TACACS DS62 privilege level..... 15
```

Serial Port Configuration

Select 2), from the Network Configuration Menu configures Handshaking, Baud Rate, Word Size, Stop Bits, and Parity through either the serial or Ethernet ports using the menus. RTS and DTR Line Drivers can only be configured through the phone line via a modem. The default settings are 9600bps, 8 data bits, no parity, one stop bit, RTS and DTR High.



IMPORTANT: Communications with the terminal computer connected to the port will be lost until the serial port configuration of the terminal computer matches the unit's serial port.

Menu 2: Serial Port Configuration

```
+-----+-----+-----+-----+-----+-----+-----+-----+-----+-----+
|Port|Device|   Device   | Baud | Word | Stop | Parity|Handshake|LineDrive|
|    |Type  |   Name    | Rate | Size | Bits |      |         |DTR  |RTS  |
+-----+-----+-----+-----+-----+-----+-----+-----+-----+-----+
|  1 | RS232| EIA-RS232 | 9600 |  8  |  1  | None | None   | HI  | HI  |
+-----+-----+-----+-----+-----+-----+-----+-----+-----+-----+

Handshaking.....1
Baud Rate.....2
Word Size.....3
Stop Bits.....4
Parity.....5
RTS Line Driver Inactive State...6
DTR Line Driver Inactive State...7

Enter Request :1
```

Handshaking

For a simple communication between modems three connected lines are needed: TX, Rx, and Ground. For the data to be transmitted, both sides have to be clocking the data at the same baud rate. While this method is sufficient for most applications, it is limited in being able to respond to problems such as the receiver getting overloaded. This is where serial handshaking can help.

Select 1), from the Serial Port Configuration Menu for the Handshaking menu, **Default is None**

Select handshaking:
1 For None
2 For Software Handshaking
3 For Hardware Handshaking
Enter Request :

Software Handshaking: This style uses actual data bytes as control characters. The lines necessary are TX, Rx, and ground since the control characters are sent over the transmission line like regular data. The two control characters, XON and XOFF are characters sent by the receiver of the data to halt the transmitter during communication.



NOTE: A drawback to this method is also the most important fact to keep in mind. In ASCII transmissions these character values are non-character values; however, data being transmitted via binary, it is very likely that these values could be transmitted as data and the transmission would fail.

Hardware Handshaking: This style uses actual hardware lines. Like the TX and Rx lines, the RTS/CTS and DTR/DSR lines work together. When a receiver is ready for data, it will assert the RTS (Request to Send) line. This is then read by the sender at the CTS (Clear to Send) input, indicating it is clear to send the data. DTR (Data Terminal Ready) and DSR (Data Set Ready) allow the serial port and the modem to communicate their status. When the modem is ready for data to be sent, it will assert the DTR line indicating that a connection has been made across the phone line. This is read in through the DSR line and the modem can begin to send data. The general rule of thumb is that the DTR/DSR lines are used to indicate that the system is ready for communication where the RTS/CTS lines are used for individual packets of data.

Baud Rate

Select 2), from the Serial Port Configuration Menu changes the transfer rate of Data bits per second for the serial port, **Default is 9600**

Select baud rate:
1 For 300
2 For 600
3 For 1200
4 For 2400
5 For 4800
6 For 9600
7 For 19200
8 For 38400
9 For 57.6K
A For 115.2K
Enter Request :

Word Size

The word size is the measurement of the actual data bits in a transmission. Which setting you choose depends on what information you are transferring. For example, standard ASCII has values from 0 to 127 (7 bits). Extended ASCII uses 0 to 255 (8 bits). If the data being transferred is simple text (standard ASCII), sending 7 bits of data per packet is sufficient for communication. A packet refers to a single byte transfer, including start/stop bits, data bits, and parity.

Select 3), from the Serial Port Configuration Menu changes the Word Size, **Default is 8**

Select word size:
1 For 5
2 For 6
3 For 7
4 For 8
Enter Request :

Stop Bits

The Stop Bits are used to signal the end of communication for a single packet. Since the data is clocked across the lines and each device has its own clock, it is possible for the two devices to become slightly out of sync. Therefore, the stop bits not only indicate the end of transmission but also give the computers some room for error in the clock speeds. The more bits that are used for stop bits, the greater the lenience in synchronizing the different clocks, but the slower the data transmission rate.

Select 4), from the Serial Port Configuration Menu changes the Stop Bits, **Default is 1**

```
Select stop bits:
1 For 1
2 For 1.5
3 For 2
Enter Request :
```

Parity

Parity is a simple form of error checking used in serial communication. For even and odd parity, the serial port will set the parity bit (the last bit after the data bits) to a value to ensure that the transmission has an even or odd number of logic high bits. For example, if the data was 011, then for even parity, the parity bit would be 0 to keep the number of logic high bits even. If the parity was odd, then the parity bit would be 1, resulting in 3 logic high bits. This allows the receiving device to know the state of a bit so as to enable the device to determine if noise is corrupting the data or if the transmitting and receiving devices' clocks are out of sync.

With no parity selected, it's assumed that there are other forms of checking that will detect any errors in transmission. No parity also usually means that the parity bit can be used for data, speeding up transmission. In modem-to-modem communication, the type of parity is coordinated by the sending and receiving modems before the transmission takes place.

Select 5), from the Serial Port Configuration Menu selects the Parity, **Default is None**

```
Select parity:
1 For None
2 For Even
3 For Odd
Enter Request :
```

RTS/DTR Line Driver Inactivity State

RTS (Request to Send)/ DTR (Data Terminal Ready) is normally used in conjunction with an external modem. With no modem the RTS and DTS **default state is High**.

Select 6), from the Serial Port Configuration Menu changes the RTS driver state, **Default is "High"**

```
RTS Line Driver Inactive State is: High
High ? (Y/N, CR for no change):
```

Select 7), from the Serial Port Configuration Menu changes the DTR driver state, **Default is "High"**

```
DTR Line Driver Inactive State is: High
High ? (Y/N, CR for no change):
```

Type **"Y"** for YES or **"N"** for NO and press 'Enter'.

Serial Port Device Name

Select 3), from the Network Configuration Menu allows the serial port to be renamed. Type the new port name and press 'Enter'.

```
Current device name: EIA-RS232
Enter device name for serial port ((1 - 16 char., CR to end) :
```

Attention Character

Pressing the Attention Character 5 consecutive times will access the network main menu. Select 4, from the Network Configuration Menu, to change the attention character. The unit displays the following: The Default is a semi-colon (;).

```
Attention Character is..... ;
Enter Attention Character :
```

Disconnect Timeguard

Select 5), from the Network Configuration Menu, ensures reliable binary data transmission by providing a one-second "Timeguard" after the unit receives the attention character. If more data is received within the delay period, the unit treats the character as data, not an attention character; thereby preventing unwanted port disconnection. Select 5, from the network menu. The Default setting is Disabled.

```
Disconnect Time Guard is..... Disabled
Enable ? (Y/N), CR for no change :
```

Connect Port ID Echo

Select 6), from the Network Configuration Menu, sets the port identification. The unit displays the Port ID Echo Menu.

```
Port ID Echo is.....Disabled
Connect Port ID Echo Menu

Disable Port ID Echo.....1
Use Module, Port Number.....2
Use Device Name.....3
Exit.....X,CR
Enter Request :
```

Select 1), disables the echo. The Default setting is Disabled.

```
The unit displays: (blank)
```

Select 2), echoes the module and port number.

```
The unit displays:
      BAYTECH

For further information check:
http://www.baytech.net/

02,1
```

Select 3), echoes the device name.

```
The unit displays:
      BAYTECH

For further information check:
http://www.baytech.net/

MRP10
```

Login Setup Menu

Select 7), from the Network Configuration Menu, allows the admin user to enable or disable the Access Control, Manage Users, Radius, and TACACS configuration. Depending on the firmware installed the Login Setup menu may be slightly different than what is shown.

Access Control

Select 1), from the Login Setup Menu, this security feature allows the admin to enable or disable usernames and passwords for both network and serial port access.

Select 1), for *Telnet login*

Type “Y” to enable Login Prompt,
Type “N” to disable prompt.
Press “Enter” to keep same setting

Select 2), for *Serial login*

Type “Y” to enable Login Prompt,
Type “N” to disable prompt.
Press “Enter” to keep same setting

If the login has been enabled you will get a prompt similar to the following:

The default user and password is **root** and **baytech**, all lower case.

Manage Users

Select 2), from the Login setup Menu, allows the administrator to add/delete users and change their passwords for multiple users. Usernames and passwords are case sensitive and alphanumeric. The root user can not be removed. Select Manage User and the unit displays the following:



NOTE: The port access mentioned in the User Management Menu below is not used in the MRP series.

Menu 4: Network Manage User

```
User Management Menu
To change user password or port access, enter number of user.
To add/delete user, select appropriate menu choice.
SNMP V3 requires passwords that are between 8 and 31 characters long
Enter request, CR to exit menus.
  A)...Add user
  1)...root
```

Type “A” and press ‘Enter’ to **Add user** and their password, the unit displays the following:

```
Enter username (<= 31 characters)>user1
Enter new password (<= 31 characters)>*****
Confirm by re-entering new password>*****
Password change successful.
```

Menu 3: Network Login

```
Access Control.....1
Manage Users.....2
Radius Configuration.....3
TACACS Configuration.....4
Exit.....X,CR
```

```
Telnet Login Prompt Enable/Disable..1
Serial Login Prompt Enable/Disable..2
```

```
Login prompt for telnet is.....Enabled
Enable ? (Y/N), CR for no change) :
```

```
Login prompt for serial is.....Disabled
Enable ? (Y/N), CR for no change) :
```

```
Universal RPC login: root
Password:
```



NOTE: If you forget your password, the administrator has to delete the user then add them back in.



IMPORTANT: You can change the admin password. If you forget, resetting the unit back to factory default is the only way to get the admin password back.

```
User Management Menu
To change user password or port access, enter number of user.
To add/delete user, select appropriate menu choice.
SNMP V3 requires passwords that are between 8 and 31 characters long
Enter request, CR to exit menus.
  A)...Add user
  D)...Delete user
  1)...user1
  2)...root
Enter Request :2
```

Select a user number, the unit displays the following menu:

```
Change Password.....1
Exit.....X
Enter Request : 1
```

Select 1), to change a user's password The unit displays the following menu:

```
User name: root
Enter old password (CR if none)>*****
```

If the user does not have a password the RPC will respond for a new password and a confirmation to re-enter the new password:

```
Enter new password (<= 31 characters)>*****
Confirm by re-entering new password>*****
Password change successful.
```

Select D), *Delete user*:

The unit re-displays the "User Menu" minus the deleted user

```
A)...Add user
D)...Delete user
1)...Engineer
2)...root
Enter Request :d

From menu above, enter number for user to delete>1

User Management Menu
To change user password or port access, enter number of user.
To add/delete user, select appropriate menu choice.
SNMP V3 requires passwords that are between 8 and 31 characters long
Enter request, CR to exit menus.
  A)...Add user
  1)...root

Enter Request :
```

Radius Configuration

Select 3), from the Log In Menu, Radius is used to authenticate logins for the serial and the network ports if passwords and user names are enabled in the unit. If the Radius server rejects either the username or password or does not respond, the unit will display “Invalid Password”.

Select 1), *Radius Enable* enables radius authentication. If enabled, the primary radius server address must be specified

Select 2), *Radius Server Address* specifies the radius server IP addresses

Select 3), *Radius Backup Server Address* specifies the backup server IP addresses

Select 4), *Radius Secret* sets the shared radius secret. A secret can be up to 16 characters and must be exactly the same as the secret stored on the server.

Select 5), *Enable URPC usernames as backup* enables URPC usernames as backup login allows an unsecured access until the RADIUS server becomes available.

Select 6), *Radius Login Timeout* sets the amount of time the unit will wait for a response from the radius server after sending the login message to the radius server. A timeout on a radius response is treated, per RFC specifications, as a rejection from the radius server

Select 7), *Radius Server Port* enables the unit to communicate with Radius Server. If you type a port number less than 1024 the Host Module responds with the same screen until a valid entry is typed.

Menu 5: Network Radius Configuration

```
Radius Enable.....1
Radius Server Address.....2
Radius Backup Server Address.....3
Radius Secret.....4
Enable URPC usernames as backup..5
Radius Login Timeout.....6
Radius Server Port.....7
Exit.....X,CR
```

Radius login is.....Disabled
Enable ? (Y/N), CR for no change) :

Radius Server IP Address is: 0.0.0.0
Enter radius server address in dotted decimal form :

Radius Backup IP Address is: 0.0.0.0
Enter radius server address in dotted decimal form :

Radius secret is: HardlyASecret
Enter radius secret (16 chars max).
:

URPC usernames as backup login is Disabled
Enable ? (Y/N), CR for no change) :

Radius response timeout is 5 seconds
Enter timeout, in seconds (>=5 and <=30) :

RADIUS server port is: 1812
Enter port number (>= 1024, D for default 1812):

TACACS Configuration

TACACS can be used to authenticate logins for the serial port, the network port, modem or all three. When a telnet / SSH session (or RS232 session) is started the Host module will prompt for the username then a password. The Host will send the username and password to the TACACS server. If the server verifies the username and password, the Host will display the menus. If the server rejects the username and password or does not respond the Host will display the reason the login failed.

Setting up TACACS

To enable TACACS for logins do the following:

- Enable TACACS from the TACACS configuration menu.
- Enter the IP address of the TACACS server
- Enter the IP address of the backup TACACS server if any.
- Enable local logins as a backup to the TACACS server if needed.
- Secret word must match the secret word in the TACACS server configuration.
- Enable URPC Privilege Level and set levels.
- Enable usernames and passwords for the network and serial port via the logins setup access control menu.

Select 4) from the Login Setup Menu displays the TACACS Configuration menu

Menu 6: Network TACACS Configuration

```
TACACS Enable.....1      Enable/Disable TACACS
TACACS Server Address.....2  TACACS server IP address 0.0.0.0
TACACS Backup Server Address....3  Backup TACACS server IP address
TACACS Secret.....4      TACACS secret key (16 char max)
Enable URPC usernames as backup..5  As written
TACACS Encryption Enable.....6  Enable/Disable encryption
TACACS login Timeout.....7     Sets Time units waits for response
TACACS Server Port.....8     Assign secure TCP port
URPC Privilege Level Enable.....9  Enable/Disable TACACS privilege
URPC Privilege Level.....10    Set Privilege Level 1-15
Exit.....X, CR
```

Select 1), *TACACS Enable* sends the login information to the TACACS server for authentication. If enabled, the primary TACACS server addresses must be specified.

```
TACACS login is.....Disabled
Enable ? (Y/N), CR for no change) :
```

Select 2), *TACACS Server Address* assigns a specific TACACS server IP addresses.

```
TACACS Server IP Address is: 0.0.0.0
Enter TACACS server address in dotted decimal form :
```

Select 3), *TACACS Backup Server Address* assigns a specific Backup Server IP addresses.

```
TACACS Backup IP Address is: 0.0.0.0
Enter TACACS server address in dotted decimal form :
```

Select 4), *TACACS Secret* assigns a secret word shared between the TACACS server and this unit. A secret can be up to 16 characters and must be exactly the same as the secret stored on the server.

```
TACACS secret is: HardlyASecret
Enter TACACS secret (16 chars max).
:
```

Select 5), *Enable URPC usernames as backup* allows an unsecured access in case all specified TACACS servers are unavailable.

```
URPC usernames as backup login is Disabled
Enable ? (Y/N), CR for no change) :
```

Select 6), *TACACS Encryption Enable* sets the TACACS+ encryption to off or on. Sending unencrypted TACACS packets is useful for troubleshooting but should not be used under normal operations.

```
TACACS encryption is.....Enabled
Enable ? (Y/N), CR for no change) :
```

Select 7), *TACACS Login Timeout* sets the amount of time the unit will wait for a response from the TACACS server.

```
TACACS response timeout is 10 seconds
Enter timeout, in seconds ( >=0 and <=30 )
0 = no timeout :
```

Select 8), *TACACS Server Port* assigns a more secure port, **default is TCP 49**. If you type a port number less than 1024 the Host Module responds with the same screen until a valid entry is typed.

```
TACACS server port is: 49
Enter port number (>= 1024, D for default 49): 12
```

TACACS User Privilege Feature

Important: The TACACS admin user must perform the following before the TACACS Privilege level to operate: Open the tacacs.conf file and add the following entry for each user: (service = exec {priv-lvl = n}). Where “n” is a number from 1 to 15, inclusive. 15 is root privilege level, 1 is lowest level user. “priv-lvl” must be spelled exactly as shown, including case. Restart the daemon after making changes.

Select 9), *URPC Privilege Level Enable* enables the unit to send a privilege level to the TACACS server. **Default is Disabled**

```
TACACS Privilege Level is.....Disabled
Enable ? (Y/N), CR for no change) :
```

Select 10), *URPC Privilege Level* assigns privilege levels. 1 is the minimum user privilege and 15 is the root/admin privilege level. **Default is 15**

```
URPC Privilege Level is: 15
Enter Privilege Level for root access:
```

Example of operation: Privilege Level enabled, set to “10”. In tacacs.conf file on daemon, user1 is configured for exec priv-lvl = 9, user2 is configured for exec priv-lvl = 10, and user3 is configured for exec priv-lvl = 11. In this scenario, user1 will get only user-level access to the power strip, user2 & user3 will get root access.

See Appendix: TACACS Connection: for troubleshooting connection problems with TACACS servers.

Network Port Configuration

Select 8), from the Network Configuration Menu, this menu is used to change the network configuration options such as the IP Address, Subnet Mask, Gateway, DHCP, and Telnet; all of which are necessary during initial startup. The *Connection Inactivity Timeout* allows you to enable/disable whether the firmware will end your session or “times out.” The default is 1 hour, but when disabled there is no set time out. Disabling the *Carriage Return Translation* allows you to bypass all unnecessary carriage returns, and it will send you straight to the next “end of line.” The *DHCP*, *Telnet*, *SSH*, options is to enable or disable these functions. SSH host key Generator allows the user to generate a host key which is used in the SSH encryption process. *IP Filter* allows or blocks specific IP

Addresses, *SNMP* provides a message format for communication between a computer and your devices, and *Web Server* Configuration allows web access and sets up options for each.

Menu 7: Network Port Configuration

```
Network setup :
Ethernet Address..... 00:C0:48:00:01:FD
IP Address..... 70.150.140.89
Subnet Mask..... 255.255.255.224
Default Gateway..... 70.150.140.65

Connection Inactivity Timeout (mins): Disabled
Carriage Return Translation: Enabled
Break Length (msecs): 350
DHCP is Disabled Telnet is Enabled SSH is Enabled
SSH host keys are set to factory default

IPv4 Configuration.....1
IPv6 Configuration.....2
Inactivity Timeout.....3
Carriage Return Translation.....4
Break Length.....5
DHCP Enable/Disable.....6
Telnet Enable/Disable.....7
SSH Enable/Disable.....8
SSH Host Key Generation.....9
IP Filter Configuration.....10
SNMP Configuration.....11
Web Server Configuration.....12
Exit.....X,CR
Enter Request :
```



NOTE: IPv6 is only available for network firmware version F4.00.00 or higher



IMPORTANT: For network access, you must configure the IPv4: IP addresses, Subnet Mask, and Gateway or IPv6: IP Address, Network Prefix Size and Gateway. A unit reset must be performed for network changes to take effect.

IPv4 Configuration

This option is for setting the IP Version-4. The menu options are IP Address, Subnet, and Gateway.

```
IP Address.....1
Subnet Mask.....2
Gateway.....3

Enter Request :
```

IP Address

The IP address is the network address assigned by your network manager for your network. The IP Address consists of four bytes, each byte ranging from 0 to 255. **This parameter must be programmed before the MRP can be accessible via the network.**

Select 1), enters the IP Address. Failure to enter the address in the decimal form causes the unit to display the following until it is entered correctly.

Default Module IP Address is 0.0.0.0.

Enter IP address in dotted decimal form :



NOTE: There should be no active connections while configuring the MRP. The unit should be reset upon completion of configuration.

Subnet Mask

The Subnet Mask is a bit mask that identifies the network portion of the IP address, allowing the RPC to determine whether to send a packet directly to the client or to a gateway. The Subnet Mask consists of four bytes, each byte ranging from 0 to 255. **This parameter must be programmed before the MRP can be accessed through the network.**

Select 2), enters the Subnet Mask followed by <cr>. Failure to enter the address in the decimal form causes the unit to display the following until it is entered correctly. **Default Subnet Mask is 0.0.0.0.**

Enter Subnet Mask in dotted decimal form :

Gateway Address

The Gateway is the address of a router to connect to other parts of a network. The Gateway address consists of four bytes, each byte ranging from 0 to 255. **If your network uses gateways, this parameter must be programmed before the MRP can be accessed through the network.**

Select 3), changes the Gateway address. Failure to enter the address in the decimal form causes the unit to display the following until it is entered correctly. **Default Gateway address is 0.0.0.0.**

Enter Gateway address in dotted decimal form :

IPv6 Configuration

This option is for setting the IP Version-6. The menu options are IPv6 Address, Network Prefix Size, and Gateway.



NOTE: Do not change unless your Network Administrator has provided you with the IPv6 network data address.

```
Ethernet Address..... 00:C0:48:0C:A6:C6
IPv6 Address..... ::/0
IPv6 Default Gateway..... ::

IPv6 Address.....1
Network Prefix Size.....2
Gateway.....3

Enter Request :
```

IPv6 Address

The IPv6 address is a 128 bit network address assigned by your network manager for your network. The IPv6 Address consists of eight groups of four hexadecimal bits separated by colons. **This parameter must be programmed before the MMP can be accessible via the network.**

Select 1), to enter the IPv6 Address. Failure to enter the address in the hexadecimal form causes the unit to display the following until it is entered correctly. **Default Module IPv6 Address is :: /0**

Enter IP address in dotted decimal form :



NOTE: There should be no active connections while configuring the MMP. The unit should be reset upon completion of configuration.

Network Prefix Size

The high-order bits of an IPv6 address (on the left as the address is written on paper) specify the network, the rest specify particular addresses in that network. Thus all the addresses in one network have the same first N bits. Those first N bits are called the "prefix". We use "/N" to denote a prefix N bits long.

Select 2), to enter the Network Prefix Size Mask followed by <cr>. Failure to enter the address in the decimal form causes the unit to display the following until it is entered correctly. **Default Subnet Mask is /0**

Enter the network prefix size in bits :

Gateway Address

The IPv6 Gateway is a 128 bit network address assigned by your network manager for your network. The IPv6 Gateway consists of eight groups of four hexadecimal bits separated by colons. **This parameter must be programmed before the MMP can be accessible via the network.**

Select 3), to change the Gateway address. Failure to enter the address in the decimal form causes the unit to display the following until it is entered correctly. **Default Gateway address is 0.0.0.0.**

Enter Gateway address in dotted decimal form :

Inactivity Timeout

Select 4), from Network Port Configuration Menu sets the amount of time the unit will wait before disconnecting if there is no activity. The enabling input can be from 1 to 120 minutes. **Default is 0 (DISABLED)**

Connection Inactivity Timeout is 0 minutes
Enter timeout, in minutes (<=120, 0 to disable) :

Carriage Return Translation

Select 5), from Network Port Configuration Menu determines what the telnet processor will do with the line-feeds and nulls after a carriage return is sent. **Enable** tells the unit Telnet processor to strip line feeds or nulls after the carriage returns. **Disable** allows the characters to pass through. **Default is "DISABLED"**.

Carriage Return Translation is.... Enabled
Enable ? (Y/N), CR for no change) :

Break Length

Select 6), from Network Port Configuration Menu adjusts the break length feature. Users may configure the RPC for a break length of 1 - 1000 milliseconds. In a Telnet session with the RPC through the serial port of a DS74, send a Telnet break command (0xF3) to the unit, the serial port will send a break signal of the programmed duration. **Default is 350 milliseconds.**

Break Length is (msec)..... 350
Enter break length, in milliseconds (<=10000, 0 to disable) :

DHCP Enable/Disable

Select 7), from Network Port Configuration Menu enables or disable the DHCP feature. Dynamic Host Configuration Protocol (DHCP) is a communications protocol that lets network administrators manage centrally and automate the assignment of Internet Protocol (IP) addresses in an organization's network. **Default setting is DISABLED.**

DHCP is.....Disabled
Enable ? (Y/N), CR for no change) :

Telnet Enable/Disable

Select 8), from Network Port Configuration Menu enables or disable the Telnet feature. Telnet is a user command and an underlying TCP/IP protocol for accessing remote devices. **Default setting is ENABLED.**

Telnet is.....Enabled
Enable ? (Y/N), CR for no change) :



IMPORTANT: changing this setting will logout all SSH and Telnet sessions

SSH Enable/Disable

Select 9), from **Network Port Configuration Menu** enables or disables the SSH feature. Secure Shell (SSH), sometimes known as Secure Socket Shell, is a Unix-based command interface and protocol for securely getting access to a remote computer. It is widely used by network administrators to control Web and other kinds of servers remotely. **Default setting is ENABLED.**

```
SSH is.....Enabled
Enable ? (Y/N), CR for no change :
```



IMPORTANT: changing this setting will logout all SSH and Telnet sessions

SSH Host Key Generation

Select 10), from **Network Port Configuration Menu** allows the user to generate a unique SSH host key for the RPC unit. This key is part of the SSH encryption process. Each RPC leaving Baytech is shipped with same default SSH host key. It is important that the user generate a new SSH host key if SSH communications will be used.

```
Generate ? (Y/N)
```



NOTE: It can take the unit up to 10 minutes to generate a new host key.

IP Filter Configuration

Select 11), from **Network Port Configuration Menu** the IP Filter Management Menu allows the admin user to pass or block certain IP Addresses. If you have no rules defined the unit may display only options (A, E, C).

Menu 8: Network IP Filter Configuration

```
Filter Management Menu
Enter request or CR,X to exit menu.

A)...Add Rule
E)...Enable IP Filtering
D)...Delete Rule
V)...View Rules
F)...Flush Rules
C)...Set Default Target

Enter Request :a
```

Select A) to **Add Rule**. Type an IP address, select whether to drop or accept the address.

```
Please enter a single ip address filter
or an ip address block in ip/<blockmask> notation.

: 70.150.140.95

Select a target option for this filter:

DROP the packet.....1
ACCEPT the packet.....2
Exit.....X,CR

Enter Request :1
```

Selecting either DROP or ACCEPT the packets and the RPC will assign filter the next rule number:

```
Filter added as Rule 1.
```

Select E), **Enable IP Filtering** enables or disables the filtering function.

```
IP Filtering is ENABLED. Enable? (Y/N): y
```



Select V), *View Rules* displays any IP filtering. **NOTE:** At least one rule must be defined for this option to be available.

Rule Num	Ip Address	Target
1	70.150.140.95	DROP
2	70.150.140.96	ACCEPT

Strike ENTER to continue

Select C), *Set Default Target* sets ALL IP Addresses to accept or drop all

The default target is.....ACCEPT
DROP ? (Y/N), CR for no change) :y

Select F), *Flush Rules* deletes all rules. The unit will respond with all filters deleted.

Are you sure you want to delete all filters? (Y/N)
Enter Request :y
All filters have been deleted.

Select D), *Delete Rule* deletes a specific rule. The unit will respond with the Filter Rule number deleted.

Delete Filter Menu
Enter rule number to delete rule, 'M' to view more rules, or 'X' to exit menu.

Rule Num	Ip Address	Target
1	70.150.140.95	DROP
2	70.150.140.96	ACCEPT
3	70.150.140.99	ACCEPT

Enter Request :2

SNMP Configuration

Select 12), from the **Network Port Configuration Menu**. This allows the admin to control whether or not a user has Read/Write access or Read access only. It also allows the admin to control which IP addresses are allowed to receive a host trap, and simply whether to enable or disable the entire SNMP function.

Menu 9: Network SNMP Configuration

```
SNMP Trap Host 1 Address.....1
SNMP Trap Host 2 Address.....2
SNMP Trap Host 3 Address.....3
SNMP Trap Host 4 Address.....4
SNMP Read-Only Community.....5
SNMP Read-Write Community.....6
SNMP Enable.....7
SNMP v3 Only Enable.....8
SNMP Authentication Traps Enable..9
Exit.....X,CR
```



IMPORTANT: You will need some knowledge of SNMP protocols in order to get the Baytech device to work with your SNMP program. Information provided is for the SNMP Agent only. Baytech Support will assist with the Agent part only. For SNMP Manger assistance refer to the vender manual or contact the vender of the SNMP software you are using.



NOTE: There are a number of shareware MIB Browsers that can be downloaded from the internet to make changes and receive traps for a quick verification test.



NOTE: To use the SNMP functions you need to download the MIB from Baytech's web site, www.baytech.net. Look under Tech Support, Docs and Downloads.



IMPORTANT: Changes do not take effect until they are saved when you leave the configuration menu. The unit will display:

Accept changes ? (Y/N) :

SNMP Trap Host IP Address is a trap management station that receives and processes traps. Traps are system alerts that the Baytech device generates when certain events occur. By default, no trap manager is defined, and no traps are issued. Up to four SNMP Trap Hosts maybe assigned to receive traps. **Select a SNMP Trap Host 1, 2, 3, 4**, the unit will display the following, **Default address is (0.0.0.0) for all Hosts.**

SNMP Trap Host 1 IP Address: 220.225.36.212
Enter new Trap Host IP Address:

SNMP Trap Host 2 IP Address: 70.154.96.10
Enter new Trap Host IP Address:

SNMP Trap Host 3 IP Address: 192.168.1.102
Enter new Trap Host IP Address:

SNMP Trap Host 4 IP Address: 192.168.2.136
Enter new Trap Host IP Address:

Community String:

SNMP community strings authenticate access to MIB objects and function as embedded passwords. In order for your SNMP script/software to access the Baytech SNMP, the community string definitions on your SNMP script/software must match the Baytech SNMP string definitions.

‘**Read**’—Gives read access to authorized management stations to all objects in the MIB except the community strings, but does not allow write access.

‘**Write**’—Gives read and write access to authorized management stations to all objects in the MIB, but does not allow access to the community strings

Select 5), ‘SNMP Read Only Community’ enters a Read Community string, the unit displays the current setting, **Default is public.**

SNMP Read Community name: public
Enter Read Community Name:

Select 6), ‘SNMP Read-Write Community’ enters a Write Community string, the unit displays the current setting, **Default is private.**

SNMP Write Community name: private
Enter Write Community Name:

Select 7), ‘SNMP Enable’ option to enable the SNMP function, the unit displays, **Default is Enabled.**

SNMP is ENABLED. Enable? (Y/N):

Select 8), SNMPv3 only Enable, is for SNMPv3 software, only the newer firmware will have this option. **Default is Disabled. Caution: The user password has to be 8-31 characters, including the “root” user. The client software will need the same password.**

SNMPv3 only is DISABLED. Enable? (Y/N):

Select 9), SNMP Authentication Traps Enabled, enables a SNMP trap to be sent if an authentication attempt failed, the unit displays, **Default is Disabled.**

SNMP Authentication traps are DISABLED. Enable? (Y/N):

Web Server Configuration

Select 13), from the Network Port Configuration Menu for the Web Server Configuration menu:

Menu 10: Web Server Configuration

Web Enable.....1
Web Login Enable.....2
Web Secure Login Enable.....3
Web Login Activity Timeout.....4
Exit.....X



NOTE: For this feature to operate the network port must have an IP Address assigned. Type the unit’s IP Address on a web browser to get the unit web page, i.e. <http://70.150.140.95>



NOTE: The web page is a quick test to see if SNMP protocol is working in the unit, if SNMP has been enabled.



IMPORTANT: Currently, all users who access the unit through the web page have administrator privilege, unless a TACACS server and privilege levels are used for authentication.

Select 1), **Web Enable**, enables or disables the web page feature, **Default is Enabled:**

Web is ENABLED. Enable? (Y/N):

Select 2), **Web Login Enable**, enables or disables the login window to the web page, **Default is Enabled**

Web Login is DISABLED. Enable? (Y/N):

Select 3), **Web Secure Login Enable**, enables or disables a secure web connection to the web page, **Default is Disabled:**

Web secure SSL connection is DISABLED. Enable? (Y/N):

Select 4), **Web Login Inactivity Timeout**, sets the Inactivity timeout to the web page, **Default is zero minutes:**

Web Connection Inactivity Timeout is 0 minutes
Enter timeout, in minutes (<=120, 0 to disable) :



IMPORTANT: If a user is still connected to the outlet controller menu, or the user does not properly release the controller, the Web page will not update.

Module Name

Select 9), from the **Network Configuration** menu changes the unit name.

Module Name is: RPC
Enter Module Name (32 chars max):

RPC Management

Select 10), from the **Network Configuration Menu**, establishes SNMP outlet traps used by a remote SNMP Manager by creating outlet groups and alarm thresholds.

Menu 11: Network RPC Management

```
Host-controlled RPC Feature Configuration
Temperature Alarm Threshold.....1
Under Voltage Alarm Threshold.....2
Over Voltage Alarm Threshold.....3
Low Current Alarm Threshold.....4
Environmental Sensors.....5
Outlet Groups.....6
Temperature units (degrees C/F)....7
RPC Cascade Mode.....8
Power Factor Threshold.....9
```

Temperature Alarm Threshold

Select 1), changes the alarm for Internal Temperature: Enter the Selection (Sel) Number and press Enter. Type a value in tenths of a degree, *i.e.* 500 = 50.0° C

Sel	M/P	Identifier	Tmp Lvl
1	2/1	MRP10	500

Enter threshold value in tenths of unit measurement (degrees,%,etc.):

Under Voltage Alarm Threshold

Select 2), changes the alarm for Low Voltage: Enter the Selection (Sel) Number and press Enter. Type a value in tenths of a volt, *i.e 900 = 90.0 volts*.

Sel	M/P	Identifier	Lo V Lvl
1	2/1	MRP10	900

Enter voltage threshold value in tenths of a volt:

Over Voltage Alarm Threshold

Select 3), changes the alarm for over voltage: Enter the Selection (Sel) Number and press Enter. Type a value in tenths of a volt, *i.e 1300 = 130.0 volts*.

Sel	M/P	Identifier	Hi V Lvl
1	2/1	MRP10	1300

Enter voltage threshold value in tenths of a volt:

Low Current Alarm Threshold

Select 4), changes the alarm for low current: Enter the Selection (Sel) Number and press Enter. Type a value in tenths of a volt, *i.e 100 = 10.0 amps*

Sel	M/P	Identifier	Low Curr
1	2/1	MRP10	0

Enter low current threshold value in tenths of an amp:



NOTE: M/P = Module number and Port number; Identifier = this unit's model number; Tmp Lvl = temperature level, Lo V Lvl = low voltage level, Hi V Lvl = High voltage level, low Curr = Low Current.

Environmental Sensors

Select 5), changes the alarm limits for the Environmental probes:
If the unit does not have a sensor probe connected, the unit will display the following.

None of the installed devices support this option (no temperature probes installed).
Strike ENTER to continue

Individual Sensors

Select 1), changes the limits of individual probes

Environmental Sensor Configuration Menu					
Sel	M/P	Identifier			
1	2/1	MRP10			
2		All Sensors			
Enter Request :1					
Sel	Type	Name	Hi/En	Lo/En	St/En
1	Contact	External Sensor1	N/A	N/A	Ds
2	Temperature	External Sensor2	0/Ds	0/Ds	N/A
Enter Request :2					

Select either 1 or 2 (Sel) probe.
(Hi/En) = Hi limit Enabled, (Lo/En) = Low limit Enabled, (St/En) = Sensor Trap enable

Second line identifies the probe name and type. Option 1 and 3 sets the temperature levels to the tenth of a degree. Option 2 and 4 enable the SNMP traps to be sent if the corresponding threshold had been exceeded

RPC/RPS External Environmental Sensor Configuration Menu		
Sensor Number: 2	Name: External Sensor2	Type: Temperature
1...High Threshold (tenths of meas. unit): 0		
2...High Threshold Trap Enable: Disabled		
3...Low Threshold (tenths of meas. unit): 0		
4...Low Threshold Trap Enable: Disabled		
Enter Request :1		

All Sensors

Select 2), sets parameters for the different probe types. This feature is useful for standardization and the probe type is known.



NOTE: The type 'Contact' signifies the unit does not recognize or detect a probe, but still be able to send SNMP Traps.

Option 1 and 3 sets the temperature levels to the tenth of a degree. Option 2 and 4 enable the SNMP traps to be sent if the corresponding threshold had been exceeded.

NOTE: NP = No Probe detected.

```
Environmental Sensor Configuration Menu
Sel M/P Identifier
1 2/1 MRP10
2 All Sensors
Enter Request :2
```

```
For configuration of all sensors of selected type in system with a
single user-supplied value.

1...Contact
2...Temperature
3...Humidity
4...Air Flow
Enter Request :1
```

```
RPC/RPS External Environmental Sensor Configuration Menu
Sensor Number: All Name: all RPCs/RPSs
Type: Temperature/Humidity/Air Flow

1...High Threshold (tenths of meas. unit): NP
2...High Threshold Trap Enable: NP
3...Low Threshold (tenths of meas. unit): NP
4...Low Threshold Trap Enable: NP
Enter Request :

Enter threshold value in tenths of unit measurement (degrees,%%,etc.):
```

Outlet Groups

Select 6), from the RPC Management Menu, allows user to combine outlets from different modules and ports. One SNMP command is used to turn off/on or reboot the group

```
Outlet Group Configuration:
List Outlet Groups.....1
Add Group.....2
Delete Group.....3
Rename Group.....4
Modify Outlets in a Group.....5
Delete All Outlet Groups.....6
Enter Request :1
```

List Outlet Groups

Select 1), lists any outlet groups:

#	Group Name	Outlets
1	Router GP-A	2.1.1,2.1.2,2.1.3,2.1.4
2	Server Row	2.1.5,2.1.6,2.1.7,2.1.8
3	Radius	2.1.9,2.1.10,2.1.11,2.1.12
4	Server backup	2.1.13,2.1.14,2.1.15,2.1.16

Add Group

Select 2), adds a new outlet group: Each outlet is represented by Mod.Port.Outlet. i.e. Mod 2 dot port dot outlet number 1 =2.1.1

```
List up to four outlets in the following form
mod.port.outlet,mod.port.outlet
2.1.1,2.1.2,2.1.3,2.1.4
```



NOTE: Mod 2.Port 1.Outlet.# is for the MASTER unit and Mod 2 .Port 2. Outlet # is for the Slave unit

The unit displays the following and asks for a name for the new Group:

```
Outlet group is currently defined as:
# Group Name      Outlets
1                 2.1.1,2.1.2,2.1.3,2.1.4
Enter name for outlet group (max 23 characters): Router GP-A
```



NOTE: Get the Group number from the *List Outlet Groups*

Delete Group

Select 3), deletes a specific outlet group, select the number of the group to be deleted. The unit will display Group Deleted.

```
Enter group number to be deleted: 3
Group deleted
```



NOTE: Get the Group number from the *List Outlet Groups*

Rename Group

Select 4), renames an outlet group's name, select the number of the group to be renamed. The unit displays the selected group and prompts for a new name:

```
Enter number of group to be renamed: 3

Outlet group is currently defined as:
# Group Name      Outlets
3                 2.1.9,2.1.10,2.1.11,2.1.12

Enter name for outlet group (max 23 characters): Radius
```



NOTE: Get the Group number from the *List Outlet Groups*

Modify Outlets in a Group

Select 5), modifies outlets in a group, select the number of the group to be modified. The unit displays the selected group and prompts for new group of outlets:

```
Enter number of group to be modified: 4

Outlet group is currently defined as:
# Group Name      Outlets
4 Server backup   2.1.13,2.1.14,2.1.15,2.1.16

List up to four outlets in the following form
mod.port.outlet,mod.port.outlet
```

Delete All Outlet Groups

Select 6), deletes all groups

```
Delete ALL outlet groups? (Y/N): y
```



Note: There will be no confirmation the groups have been deleted. Select *List Outlet Groups* to verify all outlet groups were deleted.

Temperature Units (degrees C/F)

Select 7), from the RPC Management Menu, allows a user to change the reported degrees in Celsius or Fahrenheit

The unit display either of the following:

```
Current temperature reported in degrees Celsius.  
Change to report in degrees Fahrenheit (Y/N): y  
  
Converting temp min/max thresholds...done
```

```
Current temperature reported in degrees Fahrenheit.  
Change to report in degrees Celsius (Y/N): y  
  
Converting temp min/max thresholds...done
```

RPC Cascade Mode

Select 8), from the RPC Management Menu, allow a user to connect to a non-Ethernet Baytech power strip to control outlets of both units from one menu.

Cascade Mode Enable

Select 1), enables the Cascade feature

Menu 12: Network RPC Cascade Mode

```
Mode Menu  
  
Cascade mode: Enabled  
Outlet Status Display: Enabled  
Command Confirmation: Enabled  
  
Cascade Mode Enable.....1  
Cascade Mode Status Display.....2  
Command Confirmation.....3
```



NOTE: Read the instruction carefully for the feature to operate properly.

```
RPC Cascade Mode is..... Enabled  
  
Enabling this feature will allow access and management of a BayTech Remote  
Power Device through the console (EIA-232) port via telnet/ssh/SNMP/http.  
In RPC Cascade Mode, normal console port terminal service will operate only  
when the network cable is disconnected.  
  
When Cascade Mode is changed, URPC module will *RESET* upon acceptance of  
configuration changes, at which time, cascade device should be connected  
to or disconnected from the EIA-232 port as appropriate.  
  
Enable ? (Y/N), CR for no change) :
```

Cascade Mode Status Display

Select 2), enables this unit to display both the Master/Slave outlets:

```
Enter Request :2  
RPC Outlet Status Display is..... Enabled  
Enable ? (Y/N), CR for no change) :
```

Command Confirmation

Select 3), enables the unit to ask for confirmation before executing the command

```
Enter Request :3  
Command Confirmation is..... Enabled  
Enable ? (Y/N), CR for no change) :
```

With Cascade enabled and the unit resets, two options are added to the Network Menu, Option “2” for the slave unit and option “O” for Outlet Group Control. Option “2” gains access to the slave unit through the RS232 port.

```

Module: 1
Attention Character:
MRP05          (2 ,1).....1      Master Unit Outlet Controller
MRP05          (2 ,2).....2      Slave Unit Outlet Controller
Outlet Group Control.....O      Combined Master Slave Outlet Control
Status.....S      Unit network Status
Configure.....C      Unit Configuration menu
Unit Reset.....RU      Terminates external connections,
                        does not affect outlet states.
Logout.....T      Terminates terminal session to unit

Enter Request :s

```

Option “O”, **NOT Zero but the Letter “O”**, connects the outlet controls of both units into one menu. The “Outlet Operations Menu” is a limited menu to allow the user to turn on, turn off, or reboots the outlets. The user may group up to (10) outlets to perform one command. To return to the Network menu, type the Attention Character 5-times, default is semi-colon, (;).

```

Outlet Operations Menu.
Status: 0 - Off | 1 - On | 3 - Locked On | 4 - Locked Off
CMDs: ON, OFF, REBOOT, followed by outlet menu numbers separated by commas.
Maximum of 10 outlet numbers allowed in command.
CMD followed by carriage return performs command on ALL outlets

Master Unit Outlets

1) 3 MOD 1 Outlet 1      2) 3 MOD 1 Outlet 2      3) 3 MOD 1 Outlet 3
4) 3 MOD 1 Outlet 4      5) 3 MOD 2 Outlet 1      6) 3 MOD 2 Outlet 2
7) 3 MOD 2 Outlet 3      8) 3 MOD 2 Outlet 4      9) 3 MOD 3 Outlet 1
10) 3 MOD 3 Outlet 2     11) 3 MOD 3 Outlet 3     12) 3 MOD 3 Outlet 4
13) 3 MOD 4 Outlet 1     14) 3 MOD 4 Outlet 2     15) 3 MOD 4 Outlet 3
16) 3 MOD 4 Outlet 4

Slave Unit Outlets

17) 3 MOD 1 Outlet 1     18) 3 MOD 1 Outlet 2     19) 3 MOD 1 Outlet 3
20) 3 MOD 1 Outlet 4     21) 3 MOD 2 Outlet 1     22) 3 MOD 2 Outlet 2
23) 3 MOD 2 Outlet 3     24) 3 MOD 2 Outlet 4     25) 3 MOD 3 Outlet 1
26) 3 MOD 3 Outlet 2     26) 3 MOD 3 Outlet 3     28) 3 MOD 3 Outlet 4
29) 3 MOD 4 Outlet 1     30) 3 MOD 4 Outlet 2     31) 3 MOD 4 Outlet 3
32) 3 MOD 4 Outlet 4

CMD>

```



NOTE: If connecting to the Master unit serial port and the menu is scrolling or the smiley face and heart is displayed. See Appendix: Troubleshooting for resolutions.

Power Factor Threshold Menu

Select 9), from the **RPC Management Menu**, displays the unit's power efficiency on the web page and through SNMP. The user sets a minimum power level that will send an SNMP trap to the SNMP Manager. The smaller the power factor, less than (1), more current is needed (wasted) to do the same amount work

Individual Units

Select 1), displays current Power Factor (PF) and Power Threshold settings for each individual unit circuit.

M/P = Module port,

Identifier = Unit Id,

Circuits = number of circuits on unit.

Outlets = number of unit outlets.

Select 1), displays either Circuit or Outlet Power Factor (PF)

Unit displays breaker list of circuits. Select the Circuit number to change the threshold values

Unit displays the Breaker Circuit Threshold Menu with circuit breaker number and current values.

Select 1), changes the Power Factor Threshold level. Enter a per cent value (%). **Factory Default is (0%)**.

Parameters to control generation of SNMP traps based on circuit Power/VA power factor and minimum power level

Sel	M/P	Identifier	Circuits	Outlets
1	2/1	MRP27	6	24
2	All Circuits/Outlets - Power Factor Threshold			
3	All Circuits/Outlets - Power Threshold			

Enter Request :1

Circuit Power Factor Thresholds....1
Outlet Power Factor Thresholds.....2

Enter Request :1

Breaker List for device 1, MRP-27

Ckt	PF Threshold (%)	Pwr Threshold (W)
1	100	10
2	100	10
3	100	10
4	100	10
5	100	10
6	100	10

Enter Request :1

Breaker Circuit Threshold Menu

Device 1, Breaker Circuit 1

Efficiency Threshold: 100, Power Threshold: 10

Power/VA Power Factor Threshold....1
Minimum Power Threshold.....2

Enter Request :1

Power/VA ratio threshold as a percent, between 0 and 100, inclusive. Power factors below this value will generate an SNMP trap, if enabled and power is above minimum power threshold. A value of 0 disables threshold.

Enter threshold value:



NOTE: The Power Factor Threshold SNMP alarm is sent only if both respective values drop below the Power Factor Threshold and Power Threshold at the same time.

Unit displays the Breaker Circuit Threshold Menu with current values.

Select 2), changes the Minimum Power Threshold level. Enter a value. **Factory Default is (50w).**

```

Breaker Circuit Threshold Menu
Device 1, Breaker Circuit 1
Efficiency Threshold: 100, Power Threshold: 10

Power/VA Power Factor Threshold....1
Minimum Power Threshold.....2

Enter Request :2
    
```

Minimum power required to generate an SNMP power factor trap if power factor is below threshold.

Enter threshold value:

Select 2), displays Outlet Power Factor (PF) Threshold.

```

Circuit Power Factor Thresholds....1
Outlet Power Factor Thresholds.....2

Enter Request :1
    
```

The unit displays the number of outlets on the unit. Select an outlet number to change the values for Power Factor (PF) Threshold and Power Threshold.

```

Outlet Thresholds for device 1, MRP-27
Threshold values listed next to outlet number.
Enter outlet number to change associated thresholds.

Outlet PF (%) Pwr (W) | Outlet PF (%) Pwr(W)
1 100 10 | 13 100 10
2 100 10 | 14 100 10
3 100 10 | 15 100 10
4 100 10 | 16 100 10
5 100 10 | 17 100 10
6 100 10 | 18 100 10
7 100 10 | 19 100 10
8 100 10 | 20 100 10
9 100 10 | 21 100 10
10 100 10 | 22 100 10
11 100 10 | 23 100 10
12 100 10 | 24 100 10

Enter Request :1
    
```

Unit displays the Outlet Circuit Threshold Menu with Device Outlet number and current values.

Select 1) changes the Power Factor Threshold level. Enter a per cent value (%). **Factory Default is (0%).**

```

Outlet Circuit Threshold Menu
Device 1, Outlet 1
Efficiency Threshold: 100, Power Threshold: 10

Power/VA Power Factor Threshold....1
Minimum Power Threshold.....2

Enter Request :
    
```

Power/VA ratio threshold as a percent, between 0 and 100, inclusive. Power factors below this value will generate an SNMP trap, if enabled and power is above minimum power threshold. A value of 0 disables threshold.

Enter threshold value:



NOTE: The Power Factor Threshold SNMP alarm is sent only if both respective values drop below the Power Factor Threshold and Power Threshold at the same time.

Unit displays the Outlet Circuit Threshold Menu with Device Outlet number and current values.

Select 2), changes the Minimum Power Threshold level. Enter a value. **Factory Default is (50w).**

```

Outlet Circuit Threshold Menu
Device 1, Outlet 1
Efficiency Threshold: 100, Power Threshold: 10

Power/VA Power Factor Threshold....1
Minimum Power Threshold.....2

Enter Request :

Minimum power required to generate an SNMP power factor
trap if power factor is below threshold.

Enter threshold value:

```

All Circuits/Outlets - Power Factor Threshold

This option allows user to set all circuits and outlets to the same Power Factor Threshold levels. (MMX) refers to the metered-outlet modular- series. **Default Value = (0%)**

```

Power/VA ratio threshold as a percent, between 0 and 100, inclusive.
Power factors below this value will generate an SNMP trap, if enabled and
power is above minimum power threshold. A value of 0 disables threshold.

Value will be applied to all circuits and outlets (MMX units).

Enter threshold value:

```

The unit responds with message stating the Thresholds were set to the new value and displays the Menu.

```

Setting all Power/VA Efficiency Thresholds to 80%

Power Factor Threshold Menu

Parameters to control generation of SNMP traps based on
circuit Power/VA power factor and minimum power level

Sel  M/P  Identifier      Cks  #Outs
1   2/1  MRP-27             6    24
2   All  All Circuits/Outlets - Power Factor Threshold
3   All  All Circuits/Outlets - Power Threshold

Enter Request :

```

All Circuits/Outlets - Power Threshold

This option allows user to set all circuits and outlets to the same Power Threshold levels. (MMX) refers to the metered-outlet modular series. **Default Value = (50w)**

```

Minimum power required to generate an SNMP power factor
trap if power factor is below threshold.

Value will be applied to all circuits and outlets (MMX units).

Enter threshold value:

```

The unit responds with message stating the Thresholds were set to the new value and displays the Menu.

```
Setting all minimum Power Threshold levels to 10 Watts

Power Factor Threshold Menu

Parameters to control generation of SNMP traps based on
circuit Power/VA power factor and minimum power level

Sel  M/P  Identifier      Cks  #Outs
  1  2/1  MRP-27           6    24
  2  All  Circuits/Outlets - Power Factor Threshold
  3  All  Circuits/Outlets - Power Threshold

Enter Request :
```

Firmware/Config Download

Menu 13: Network Firmware/Config Download

Select 11), from the Network Configuration Menu, upgrades the firmware for IP Network, Outlet controller, Uploaded SSL Certificates, and Configuration file.

```
Enable Firmware Upgrade.....1
Enable SSL Cert Upload.....2
Enable Configuration File Upload..3
Restore Configuration Defaults....4
Get Current Configuration File....5
Display Configuration Error Log...6
Enable Rel Ctl. Firmware Upgrade..7
Exit.....X,CR
```

Enable Firmware Upgrade

Select 1), enables the upgrade of the firmware via FTP. The unit will display the following, **Default is Disabled**:

```
Enabling this will allow the firmware to be updated via ftp
Enable Firmware Upgrade ? (Y/N)
```



IMPORTANT: Do not type “Y” unless you have received the instructions and firmware from Baytech’s Technical Support. If you typed “Y” and see the following below, turn power off than back on to the unit to close the firmware upgrade.

Selecting “Y” for yes the unit will display the following as it waits for the firmware file,

```
Waiting to receive compressed image file
-----
-----
```

At this point follow the FTP program instruction to transfer the firmware into the unit.

Enable SSL Cert Upload

Select 2), allows the admin to upload an SSL Certificate to the unit via FTP. The filename of the certificate must be (ssl.pem). An SSL certificate is used by the unit to create secure web connections. The unit is shipped with a default SSL certificate. This certificate should be replaced with one that better suits the user’s environment. The file format is checked after download to insure that the certificate is valid.

The unit will display the following:

```
Enabling this will allow the SSL Certificate to be updated via ftp
Enable SSL Certificate Upload? (Y/N)
```



IMPORTANT: If you type “Y”, the unit will display the following. To stop this function power-cycle the unit to close the SSL Certification Upload.

Selecting “Y” for yes the unit will display the following as it waits for the certificate.

```
Waiting to receive ssl.pem SSL certificate file
-----
```

At this point follow the FTP instruction to transfer the ssl.pem file into the module.

Enable Configuration File Upload

Select 3), allows the admin to upload a configuration file from a computer to the power unit. The unit will display the following:

```
Enabling this will allow the system configuration to be updated via ftp
THE UNIT WILL RESET AFTER CONFIGURATION IS COMPLETE
Enable Configuration File Upload? (Y/N)
```



IMPORTANT: If you type “Y”, the unit displays the following below. To stop this function power-cycle the unit to close the Configuration File Upload.

```
Waiting to receive configuration file
-----
-----
```

At this point FTP the file into the unit. A successful file upload and the unit will display:

```
configuration file valid

updating ds62 configuration
***
ds62 host configuration complete
polling rpcs
Found RPC at mod 2 port 1
rpc polling complete
configuring rpcs
```

Unsuccessful file upload and the unit will display:

```
***error in config upload file or transfer operation***
```



NOTE: This part of the program is derived from the DS62 module program, thus the DS62 reference.

Restore Configuration Defaults

Select 4), allows the admin to restore the unit configuration to factory defaults.



NOTE: The network **default** IP Address, Subnet, and Gateway is **0.0.0.0**

The unit will display the following:

```
ENABLING THIS WILL ERASE ALL CONFIGURATION BACK
TO FACTORY DEFAULTS AND RESET THE UNIT
Set Configuration to Factory Defaults? (Y/N)
```

A YES response and the unit will display:

```
SETTING DEFAULT CONFIGURATION
set default password file
USING DEFAULT SSL CERTIFICATE

System reset in progress...

This board is a Universal RPC Controller
.....Uncompressing...done.
```

Get Current Configuration File

Select 5), allows the admin to get a copy of the current unit configuration file from the unit and FTP's it to a computer. The configuration file to be uploaded is named "confupload". The file may be opened with any ASCII or text file editor.



NOTE: Save a copy of the "confupload" file under a different name, just in case a mistake is made that prevents the unit from operating properly. If the unit appears to not respond, power-cycle the unit and type semi-colon five times. If it appears the unit is still not responding, follow the reset procedures to reset the module.

Select Get Current Configuration File and the unit will display.

```
Enabling this will allow the system configuration
file to be retrieved via ftp
Enable Configuration File Retrieval? (Y/N)
```

A YES response and the unit will display the following:

```
/var/confupload file created and ready for ftp
retrieval

Waiting to send configuration file
-----
-----
```

At this point FTP the file to your computer. A Successful file retrieval and the unit displays:

```
get of configuration file complete
```

Unsuccessful file retrieval and the unit displays:

```
***error in config upload file or transfer operation***
```

Display Configuration Error Log

Select 6), lists any errors in uploading or downloading the configuration file, the unit will display either:

```
no errors
Press CR to continue
OR
1. No communication with rpc at mod 3 port 1 (MRP:5)
Press CR to continue
```

Enable Rel Ctl. Firmware Upgrade

Select 7), upgrades the outlet controller firmware, the unit will display the available controllers:

```
RPC Firmware Upgrade Menu

MRP105          (2 ,1).....1
MRP105          (2 ,2).....2

Enter Request :
```

Select the controller to be upgraded and the unit will ask if this is the correct controller to enable firmware upgrade. It will also tell you which port you are connected which will determine which method to upload the firmware.

If the unit displays the following, type “Y” at the prompt. The unit will wait for the ASCII file to be transfer. An error will occur if the terminal program

```
Upgrading RC firmware on RPC at module 2, port 1.

Enable update of Relay Controller firmware via Console (RS232) port.
Enabling will reset Ethernet Module when Configuration is exited

Enable Firmware Upgrade ? (Y/N) y

Send RC firmware file using ASCII file transfer option
on your Terminal program.

Waiting for RC firmware.
-----
```



CAUTION: The unit may not read the data correctly if the terminal program tries to upload the file as a modem file, i.e. ZModem. Verify the file transfer is ASCII.

If the unit displays the following, type “Y” at the prompt. The unit will wait for the ASCII file to be transfer via FTP.

```
Upgrading RC firmware on RPC at module 2, port 1.

Enable update of Relay Controller firmware via Console FTP.
Enabling will reset Ethernet Module when Configuration is exited

Enable Firmware Upgrade ? (Y/N) y

Send file in ASCII file mode.

Waiting for RC firmware.
-----
```

UNIT RESET

Select **RU**), resets the unit to the current configurations, the unit will display:

```
Reset Unit? (Y/N)
```



NOTE: A Unit Reset takes approximately 20 seconds for the unit to reset. **It will not affect the state the energized outlets.** It will not reset the unit to “Factory Default”, but it will terminate all external communications.

LOGOUT

Select **T**), will close the session to the unit, but **may not** close the terminal emulator session.

BAYTECH PRODUCT WARRANTY

Bay Technical Associates (BayTech) warrants that its products will be free from defects in materials and workmanship under normal use for a period of two years from date of purchase (or from date of shipment from BayTech if proof of purchase is not provided).

During this warranty period, BayTech shall, at its discretion, either repair or exchange any defective product at no charge for labor and materials, or refund the amount paid for the product, less shipping and handling charges. Any replacement and/or repaired products are warranted for the remainder of the original warranty.

The customer is responsible for properly packaging the product and for shipping costs for returns. The customer is liable for loss or damage to the product during shipping, as well as any other fees or charges associated with transporting the product back to BayTech. BayTech will pay return costs for delivery within the Continental United States.

All repair and return shipments must be approved by BayTech and must be accompanied by an RA (return authorization) number. Please refer to our Repair and Return Policy below.

For the initial 30 days from the original date of shipment, any unopened product may be returned to BayTech, accompanied by an RA number. Full purchase price will be refunded, provided that the product is in excellent condition. A product may not be returned after 30 days from the original date of shipment unless approved by BayTech management.

For additional information or more specific warranty issues, contact BayTech's Technical Support or Customer Service Departments at (800) 523-2702 or (228) 563-7334.

Exceptions

This warranty does not cover misuse or minor imperfections that fall within design specifications or that do not materially alter functionality. BayTech does not warrant and is not responsible for damages incurred in shipping and handling or caused by disasters (such as fire, flood, wind, earthquake, lightning, power surges or water).

The warranty will be voided regarding products that have been neglected, altered, abused, misused, or used for purposes other than those for which it was designed.

Under no circumstances shall BayTech be liable for any special, incidental, or consequential damages based upon breach of warranty, breach of contract, negligence, strict liability, or any other legal theory. Such damages include (but are not limited to) loss of profits, loss of the product or associated equipment, cost of capital, cost of substitute or replacement equipment, facilities or services, down time, purchaser's time, the claims of third parties, including customers, and injury to property.

BayTech Extended Warranty

Extended warranties and but only at the time of product purchase. The extended warranty cost will not exceed 7% per year of the product list price unless otherwise stated in the customer contract or approved by BayTech management. Contact BayTech for further details on this.

Technical Support

BayTech offers Tech Support for the lifetime of the product. A staff of Applications Engineers is on duty to assist with installation, set up or operation issues. Support is available from 8:00 a.m. to 5 p.m. (CST or CDT), Monday through Friday at the phone numbers or website provided below.

Please have the following information available to help the Applications Engineers answer questions efficiently:

- BayTech model type
- Unit serial number
- Firmware version (if accessible)
A list of devices connected to the BayTech unit
- A general description of the application being used and the intended outcome
- Information about cables and adapters being used (type, length, place of purchase)
- The name of the software emulation program being used
- Printout of the configuration status (if possible)

Bay Technical Associates, Inc.
5239 A Avenue
Long Beach Industrial Park
Long Beach, MS 39560

Telephone: 800-523-2702 or 228.563.7334
FAX: 228.563.7335
Email: support@baytech.net
Website: www.baytech.net

Repair Policy

(Return policy refers to BayTech products purchased and returned for credit or repair.)

A Return Authorization (RA) number must be obtained in all cases before returning the BayTech product. Have the **serial number** and **reason for the return or description of the problem handy**. Customers in the Continental U.S. can call 1-800-523-2702 or international customers can call 228.563.7334 to obtain an RA number.

Before dismantling equipment or returning the unit for any reason, *always contact BayTech*. Attempting to repair a product without BayTech authorization may result in voiding the warranty.

Cost and Time:

The cost of repair for units no longer under warranty will be **\$50.00** per hour plus **cost of materials** and **return shipping**

Follow the instructions below for repackaging and shipping. **NOTE: Power should be disconnected from the power source before servicing or dismantling.**

Return Authorization Process:

- a. Contact BayTech via Phone, Fax, or Email to get a Return Authorization (RA) Number.
IMPORTANT: BayTech will not accept any returns without an RA number.
- b. Package the unit carefully in its original packaging or similar packaging. The warranty does not cover damage sustained during shipment. Enclose a letter with name, address, RA number, daytime phone number and description of the problem.
- c. Mark the RA number clearly on the outside of the package.
- d. Ship the unit by insured, prepaid carrier to the following address:

Bay Technical Associates
5239 A Avenue
Long Beach Industrial Park
Long Beach, MS 39560
RA #: 140-xxxxx

APPENDIX: TACACS CONNECTION SCENERIOS

Parameters to determine if user should be able to log in:

- TACACS enabled/disabled
- Good/Bad TACACS connection
- “Enable URPC usernames as backup” enabled/disabled
- Username/password on TACACS and power strip are same/different

Same username and password in TACATCS+ and URPC

- **Case 1:** TACACS+ enabled, TACACS contact good, “Enable URPC usernames as backup” = enabled, user Log in **OK**. Log in is validated by the TACACS server.
- **Case 2:** TACACS+ enabled, TACACS contact good, “Enable URPC usernames as backup” = disabled, user Log in **OK**. Log in is validated by the TACACS server.
- **Case 3:** TACACS+ disabled, or TACACS+ contact loss, “Enable URPC usernames as backup” = enabled, user Log in **OK**. URPC validates the user.
- **Case 4:** TACACS+ disabled, or TACACS+ contact loss, “Enable URPC usernames as backup” = disabled, user Log in **FAIL**. Neither TACACS+ nor the URPC can validate the user.

Different username and password in TACACS+ and power strip: *TACACS+ username Login*

- **Case 1:** TACACS+ enabled, TACACS+ contact good, “Enable URPC usernames as backup” = disabled, TACACS username Log in **OK**. Log in validated by the TACACS+ server.
- **Case 2:** TACACS+ enabled, TACACS contact good, “Enable URPC usernames as backup” = enabled, TACACS username Log in **OK**. Log in validated by the TACACS+ server.
- **Case 3:** TACACS+ disabled or TACACS+ contact lost, “Enable URPC usernames as backup” = disabled, TACACS username Log in **FAIL**. TACACS+ not validate the user.
- **Case 4:** TACACS+ disabled or TACACS+ contact loss, “Enable URPC usernames as backup” = enabled, TACACS username Log in **FAIL**. TACACS+ not validate the user.

Different username and password in TACACS+ and power strip: *Power Strip username Login*

- **Case 1:** TACACS+ enabled, TACACS+ contact good, “Enable URPC usernames as backup” = enabled, Power Strip username Log in **OK**. Power strip validates the user.
- **Case 2:** TACACS+ disabled or TACACS+ contact loss, “Enable URPC usernames as backup” = enabled, Power Strip username Log in **OK**. Power strip validates the user.
- **Case 3:** TACACS+ enabled, TACACS+ contact good, “Enable URPC usernames as backup” = disabled, Power Strip username Log in **FAIL**. Power strip not validate the user.
- **Case 4:** TACACS+ disabled or TACACS+ contact loss, “Enable URPC usernames as backup” = disabled, Power Strip username Log in **FAIL**. Power strip not validate the user.

HORIZONTAL Rack Mounts

Each horizontal, Baytech unit is shipped with a set of horizontal brackets, and four screws packaged in a bubble-wrap bag.

1U Bracket, part number: M140R115

Attach brackets to the each of the unit's side panel with two screws. Verify both brackets are facing the same direction on the unit, once attached.

M140R115

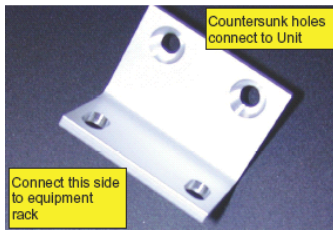

1U side panel

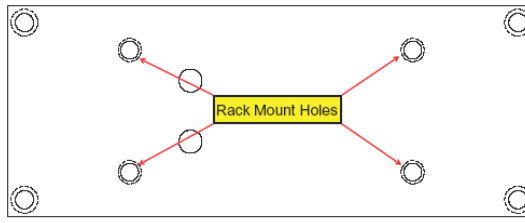

2U Bracket, part number: M140R114

Attach brackets to the each of the unit's side panel with two screws. Verify both brackets are facing the same direction on the unit, once attached.

M140RC114



U2 side panel

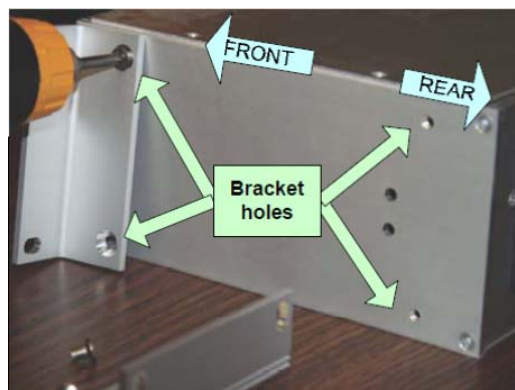

Attach brackets and unit to rack with four screws as shown below.



Rack Mount Hardware

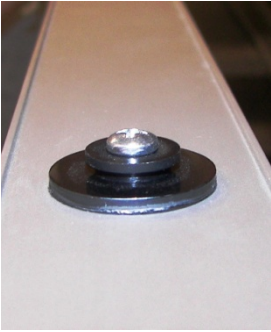

Tool Less hardware installed on back of unit. If hardware is not needed, remove with Phillips screwdriver.

Instructions to install M140C138 brackets to the Baytech vertical power strip.

- In each unit locate the small bubble wrapped brackets containing two brackets and four screws. See figure 1 and 2.

Figure1



Figure2



- Line up the bracket holes to the holes on the unit. Figure 3.

Figure 3



- Screw in two screws. Figures 4, 5, & 6 show the bracket mounted in three different positions.

Figure 4



Figure 5



Figure 6



APPENDIX: TROUBLESHOOTING

SCROLLING MENU: This may occur in a Master/Slave setup, due to the Master unit being power-up after the Slave unit and the 8” data cable connecting the serial ports of the Master and Slave together.

CORRECTIVE ACTION: Type “Ctrl+C” then press ‘Enter’ to refresh the menu. The keyboard “Alt+Break” may also work in some programs. The terminal program may have a break command that may also stop the scrolling. The three break commands work in MS-Hyper-Terminal, Putty, and Reflections.

SMILEY FACE and HEART Symbols (☺♥): Connecting to the EAI232 serial port, the cursor is jumping back and forth from the Face to the space to the right of the Heart. If these two symbols are displayed, the Master unit has the Cascade feature enabled and the Ethernet cable is connected. Some terminal programs will have the cursor do a line-feed and the program appears not to respond.

CORRECTIVE ACTION: Disconnect the Ethernet cable and wait about 10 seconds for the serial port to revert back to the normal operations with the menu.